



Before using the V-40HD, ensure that its system program is at the most recent version. For information on available upgrades for the system program, see the Roland website (<http://www.roland.com/support/>).

V-40HD

MULTI-FORMAT VIDEO SWITCHER

Owner's Manual

Roland

Owner's Manual (this document)

Read this first. It explains the basic things you need to know in order to use the V-40HD.

PDF Manual (download from the Web)

• Remote Control Guide

This describes the settings to make when operating the unit from a remote device via MIDI or the RS-232C interface.

To obtain the PDF manual

1. Enter the following URL in your computer.
<http://www.roland.com/manuals/>
▼
2. Choose "V-40HD" as the product name.

Copyright © 2012 ROLAND CORPORATION

All rights reserved. No part of this publication may be reproduced in any form without the written permission of ROLAND CORPORATION.

For the U.K.

IMPORTANT: THE WIRES IN THIS MAINS LEAD ARE COLOURED IN ACCORDANCE WITH THE FOLLOWING CODE.

BLUE: NEUTRAL
BROWN: LIVE

As the colours of the wires in the mains lead of this apparatus may not correspond with the coloured markings identifying the terminals in your plug, proceed as follows:

The wire which is coloured BLUE must be connected to the terminal which is marked with the letter N or coloured BLACK.
The wire which is coloured BROWN must be connected to the terminal which is marked with the letter L or coloured RED.
Under no circumstances must either of the above wires be connected to the earth terminal of a three pin plug.

USING THE UNIT SAFELY

Before using this unit, carefully read the sections entitled "USING THE UNIT SAFELY" and "IMPORTANT NOTES" (p. 5). These sections provide important information concerning the proper operation of the unit. Additionally, in order to feel assured that you have gained a good grasp of every feature of your new unit, read Owner's manual in its entirety. This manual should be saved and kept on hand as a convenient reference.

INSTRUCTIONS FOR THE PREVENTION OF FIRE, ELECTRIC SHOCK, OR INJURY TO PERSONS

About ⚠ WARNING and ⚠ CAUTION Notices

⚠ WARNING	Used for instructions intended to alert the user to the risk of death or severe injury should the unit be used improperly.
⚠ CAUTION	Used for instructions intended to alert the user to the risk of injury or material damage should the unit be used improperly. * Material damage refers to damage or other adverse effects caused with respect to the home and all its furnishings, as well to domestic animals or pets.

About the Symbols

	The ⚠ symbol alerts the user to important instructions or warnings. The specific meaning of the symbol is determined by the design contained within the triangle. In the case of the symbol at left, it is used for general cautions, warnings, or alerts to danger.
	The ⓧ symbol alerts the user to items that must never be carried out (are forbidden). The specific thing that must not be done is indicated by the design contained within the circle. In the case of the symbol at left, it means that the unit must never be disassembled.
	The ⏻ symbol alerts the user to things that must be carried out. The specific thing that must be done is indicated by the design contained within the circle. In the case of the symbol at left, it means that the power-cord plug must be unplugged from the outlet.

ALWAYS OBSERVE THE FOLLOWING

⚠ WARNING

Do not disassemble or modify by yourself

- Do not open (or modify in any way) the unit or its AC adaptor.



Do not repair or replace parts by yourself

- Do not attempt to repair the unit, or replace parts within it (except when this manual provides specific instructions directing you to do so). Refer all servicing to your retailer, the nearest Roland Service Center, or an authorized Roland distributor, as listed on the "Information" sheet.



Do not use or store in the following types of locations

- Subject to temperature extremes (e.g., direct sunlight in an enclosed vehicle, near a heating duct, on top of heat-generating equipment); or are
- Damp (e.g., baths, washrooms, on wet floors); or are
- Exposed to steam or smoke; or are
- Subject to salt exposure; or are
- Humid; or are
- Exposed to rain; or are
- Dusty or sandy; or are
- Subject to high levels of vibration and shakiness.



Do not place in an unstable location

- Make sure you always have the unit placed so it is level and sure to remain stable. Never place it on stands that could wobble, or on inclined surfaces



⚠ WARNING

Use only the supplied AC adaptor and the correct voltage

- Be sure to use only the AC adaptor supplied with the unit. Also, make sure the line voltage at the installation matches the input voltage specified on the AC adaptor's body. Other AC adaptors may use a different polarity, or be designed for a different voltage, so their use could result in damage, malfunction, or electric shock.



Use only the included power cord

- Use only the attached power-supply cord. Also, the supplied power cord must not be used with any other device.



Do not bend the power cord or place heavy objects on it

- Do not excessively twist or bend the power cord, nor place heavy objects on it. Doing so can damage the cord, producing severed elements and short circuits. Damaged cords are fire and shock hazards!



Avoid extended use at high volume

- This unit in combination with an amplifier and headphones or speakers, may be capable of producing sound levels that could cause permanent hearing loss. Do not operate for a long period of time at a high volume level, or at a level that is uncomfortable. If you experience any hearing loss or ringing in the ears, you should immediately stop using the unit, and consult an audiologist.



Don't allow foreign objects or liquids to enter unit; never place containers with liquid on unit

- Do not place containers containing liquid (e.g., flower vases) on this product. Never allow foreign objects (e.g., flammable objects, coins, wires) or liquids (e.g., water or juice) to enter this product. Doing so may cause short circuits, faulty operation, or other malfunctions.



WARNING

Turn off the unit if an abnormality or malfunction occurs

- Immediately turn the unit off, remove the AC adaptor from the outlet, and request servicing by your retailer, the nearest Roland Service Center, or an authorized Roland distributor, as listed on the "Information" sheet when:
 - The AC adaptor, the power-supply cord, or the plug has been damaged; or
 - If smoke or unusual odor occurs
 - Objects have fallen into, or liquid has been spilled onto the unit; or
 - The unit has been exposed to rain (or otherwise has become wet); or
 - The unit does not appear to operate normally or exhibits a marked change in performance.

Adults must provide supervision in places where children are present

- When using the unit in locations where children are present, be careful so no mishandling of the unit can take place. An adult should always be on hand to provide supervision and guidance.

Do not drop or subject to strong impact

- Protect the unit from strong impact. (Do not drop it!)

Do not share an outlet with an unreasonable number of other devices

- Do not force the unit's power-supply cord to share an outlet with an unreasonable number of other devices. Be especially careful when using extension cords - the total power used by all devices you have connected to the extension cord's outlet must never exceed the power rating (watts/amperes) for the extension cord. Excessive loads can cause the insulation on the cord to heat up and eventually melt through.

Do not use overseas

- Before using the unit in a foreign country, consult with your retailer, the nearest Roland Service Center, or an authorized Roland distributor, as listed on the "Information" sheet.

CAUTION

Place in a well ventilated location

- The unit and the AC adaptor should be located so their location or position does not interfere with their proper ventilation.

Grasp the plug when connecting or disconnecting the AC adaptor

- Always grasp only the plug on the AC adaptor cord when plugging into, or unplugging from, an outlet or this unit.

CAUTION

Periodically clean the AC adaptor's plug

- At regular intervals, you should unplug the AC adaptor and clean it by using a dry cloth to wipe all dust and other accumulations away from its prongs. Also, disconnect the power plug from the power outlet whenever the unit is to remain unused for an extended period of time. Any accumulation of dust between the power plug and the power outlet can result in poor insulation and lead to fire.

Manage cables for safety

- Try to prevent cords and cables from becoming entangled. Also, all cords and cables should be placed so they are out of the reach of children.

Avoid climbing on top of the unit, or placing heavy objects on it

- Never climb on top of, nor place heavy objects on the unit.

Do not connect or disconnect the AC adaptor with wet hands

- Never handle the AC adaptor or its plugs with wet hands when plugging into, or unplugging from, an outlet or this unit.

Disconnect everything before moving the unit

- Before moving the unit, disconnect the AC adaptor and all cords coming from external devices.

Unplug the AC adaptor from the outlet before cleaning

- Before cleaning the unit, turn it off and unplug the AC adaptor from the outlet (p. 12).

If there is a possibility of lightning strike, disconnect the AC adaptor from the outlet

- Whenever you suspect the possibility of lightning in your area, disconnect the AC adaptor from the outlet.

Keep small items out of the reach of children

- To prevent accidental ingestion of the parts listed below, always keep them out of the reach of small children.
 - Included Parts
 - RCA-BNC conversion plug

Handle the ground terminal carefully

- If you remove the screw from the ground terminal, be sure to replace it; don't leave it lying around where it could accidentally be swallowed by small children. When refastening the screw, make that it is firmly fastened, so it won't come loose.

Take care not to get burned

- The bottom panel may become hot, so take care to avoid burns.

IMPORTANT NOTES

Power Supply

- Do not connect this unit to same electrical outlet that is being used by an electrical appliance that is controlled by an inverter or a motor (such as a refrigerator, washing machine, microwave oven, or air conditioner). Depending on the way in which the electrical appliance is used, power supply noise may cause this unit to malfunction or may produce audible noise. If it is not practical to use a separate electrical outlet, connect a power supply noise filter between this unit and the electrical outlet.
- The AC adaptor will begin to generate heat after long hours of consecutive use. This is normal, and is not a cause for concern.
- To prevent malfunction and equipment failure, always make sure to turn off the power on all your equipment before you make any connections.
- With the factory settings, the V-40HD will automatically be switched off when the conditions described below continue for 240 minutes. If you don't want the unit to turn off automatically, refer to "Menu Operations" (p. 45) and turn the [AUTO OFF] setting to [OFF] in System menu (p. 50).
 - No operation of the unit (including operation by remote control)
 - No video input
 - No audio input at -48 dBu or higher

* The settings you were editing will be lost when the unit is turned off. If you want to keep your settings, you must save your settings before turning the unit off.

Placement

- Using the unit near power amplifiers (or other equipment containing large power transformers) may induce hum. To alleviate the problem, change the orientation of this unit; or move it farther away from the source of interference.
- This device may interfere with radio and television reception. Do not use this device in the vicinity of such receivers.
- Noise may be produced if wireless communications devices, such as cell phones, are operated in the vicinity of this unit. Such noise could occur when receiving or initiating a call, or while conversing. Should you experience such problems, you should relocate such wireless devices so they are at a greater distance from this unit, or switch them off.
- Do not expose the unit to direct sunlight, place it near devices that radiate heat, leave it inside an enclosed vehicle, or otherwise subject it to temperature extremes. Excessive heat can deform or discolor the unit.
- When moved from one location to another where the temperature and/or humidity is very different, water droplets (condensation) may form inside the unit. Damage or malfunction may result if you attempt to use the unit in this condition. Therefore, before using the unit, you must allow it to stand for several hours, until the condensation has completely evaporated.
- Depending on the material and temperature of the surface on which you place the unit, its rubber feet may discolor or mar the surface.
- You can place a piece of felt or cloth under the rubber feet to prevent this from happening. If you do so, please make sure that the unit will not slip or move accidentally.
- Do not put anything that contains water on this unit. Also, avoid the use of insecticides, perfumes, alcohol, nail polish, spray cans, etc., near the unit. Swiftly wipe away any liquid that spills on the unit using a dry, soft cloth.

Maintenance

- For everyday cleaning wipe the unit with a soft, dry cloth or one that has been slightly dampened with water. To remove stubborn dirt, use a cloth impregnated with a mild, non-abrasive detergent. Afterwards, be sure to wipe the unit thoroughly with a soft, dry cloth.
- Never use benzene, thinners, alcohol or solvents of any kind, to avoid the possibility of discoloration and/or deformation.

Repairs and Data

- Please be aware that all data contained in the unit's memory may be lost when the unit is sent for repairs. Important data should always be backed up to USB memories, or written down on paper (when possible). During repairs, due care is taken to avoid the loss of data. However, in certain cases (such as when circuitry related to memory itself is out of order), we regret that it may not be possible to restore the data, and Roland assumes no liability concerning such loss of data.

Additional Precautions

- Please be aware that the contents of memory can be irretrievably lost as a result of a malfunction, or the improper operation of the unit. To protect yourself against the risk of losing important data, we recommend that you periodically save a backup copy of important data you have stored in the unit's memory to USB memories.
- Unfortunately, it may be impossible to restore the contents of data that was stored in the unit's internal memory or USB memories once it has been lost. Roland Corporation assumes no liability concerning such loss of data.
- Use a reasonable amount of care when using the unit's buttons, sliders, or other controls; and when using its jacks and connectors. Rough handling can lead to malfunctions.
- When disconnecting all cables, grasp the connector itself, never pull on the cable. This way you will avoid causing shorts, or damage to the cable's internal elements.
- To avoid disturbing others nearby, try to keep the unit's volume at reasonable levels.
- When you need to transport the unit, package it in the box (including padding) that it came in, if possible. Otherwise, you will need to use equivalent packaging materials.
- Some audio connection cables contain resistors. Do not use cables that incorporate resistors for connecting to this unit. The use of such cables can cause the sound level to be extremely low, or impossible to hear. For information on cable specifications, contact the manufacturer of the cable.

Before Using USB Memories

- Carefully insert the USB memories all the way in - until it is firmly in place.
- Never touch the terminals of the USB memories. Also, avoid getting the terminals dirty.
- USB memories are constructed using precision components; handle the memories carefully, paying particular note to the following.
 - To prevent damage to the cards from static electricity, be sure to discharge any static electricity from your own body before handling the cards.
 - Do not touch or allow metal to come into contact with the contact portion of the cards.
 - Do not bend, drop, or subject cards to strong shock or vibration.
 - Do not keep cards in direct sunlight, in closed vehicles, or other such locations.
 - Do not allow cards to become wet.
 - Do not disassemble or modify the cards.

About Intellectual Property Rights

- Roland is either registered trademark or trademark of Roland Corporation in the United States and/or other countries.
- All product names mentioned in this document are trademarks or registered trademarks of their respective owners.
- It is forbidden by law to make an audio recording, video recording, copy or revision of a third party's copyrighted work (musical work, video work, broadcast, live performance, or other work), whether in whole or in part, and distribute, sell, lease, perform, or broadcast it without the permission of the copyright owner.
- Do not use this product for purposes that could infringe on a copyright held by a third party. We assume no responsibility whatsoever with regard to any infringements of third-party copyrights arising through your use of this product.
- This product can be used to record or duplicate audio or visual material without being limited by certain technological copy-protection measures. This is due to the fact that this product is intended to be used for the purpose of producing original music or video material, and is therefore designed so that material that does not infringe copyrights belonging to others (for example, your own original works) can be recorded or duplicated freely.
- MMP (Moore Microprocessor Portfolio) refers to a patent portfolio concerned with microprocessor architecture, which was developed by Technology Properties Limited (TPL). Roland has licensed this technology from the TPL Group.

Check the Included Items

The following items are included. Please make sure that all items are present. If anything is missing, please contact your dealer.

V-40HD itself



Owner's manual



AC adaptor and power cord



RCA - BNC conversion plug (four)



The explanations in this manual include illustrations that depict what should typically be shown by the display. Note, however, that your unit may incorporate a newer, enhanced version of the system (e.g., includes newer sounds), so what you actually see in the display may not always match what appears in the manual.

Contents

USING THE UNIT SAFELY	3
IMPORTANT NOTES	5
Check the Included Items	7
About the Preview Monitor	10
Connecting the Monitor.....	10
About the View on the Preview Monitor	10
About the Menu Displays.....	11
About the Power Supply.....	12
Connecting the AC Adapter.....	12
Turning the Power On and Off.....	13
Part Names and Functions.....	14
Top Panel.....	14
Rear Panel	16
Connecting External Equipment.....	17
Signal Flow	17
Connecting Source Equipment.....	19
Connecting Video Sources.....	19
Connecting Audio Sources	21
Sharing a Source Between Channels	21
Connecting Output Equipment.....	22
Connecting a Projector or Recording Unit.....	22
Connecting Tally-capable Equipment	23
About Input/Output Formats	24
Input Formats.....	24
Using the Menus to Set the Output Format for OUTPUT 1/2.....	24
Using the Buttons to Change the Output Format for OUTPUT 1/2	25
Output Formats from the Connectors.....	25
Inputting HDCP Signals	26

Basic Operations	28
Checking the Currently Selected Channels.....	28
Switching Video in the PGM/PST Mode	28
Switching the Video Using Buttons	28
Switching the Video Using the Video Fader.....	30
Switching in the A/B Mode.....	31
Changing the Operation Mode	31
Switching in the A/B Mode.....	32
Applying Fade to Final Output.....	33
Compositing the Video	34
Compositing Using Picture-in-Picture.....	34
Compositing Using DSK	35
Audio-related Features	37
Selecting an Audio Source.....	37
Adjusting the Audio Output Level.....	37
Aligning the Timing of Video and Audio (Lip-sync).....	38
Linking Audio to Video (Audio Follow)	38
About Other Features	39
Enlarging/Reducing the Picture	39
Saving/Recalling Settings	40
Using a USB Memory Device.....	41
Changing the Preview Labels	43
Returning to the Factory-default State	44
Menu Operations and Menu List.....	45
Menu Operations	45
Menu List.....	46
Appendices	52
Main Specifications	52
About Remote Control	53
About the Security Slot.....	53
Dimensions	53
Troubleshooting.....	54
Index	56

About the Preview Monitor

Connecting the Monitor

To operate the V-40HD, a preview monitor must be connected. Connect a monitor that supports HDMI input to the PVW OUT connector.

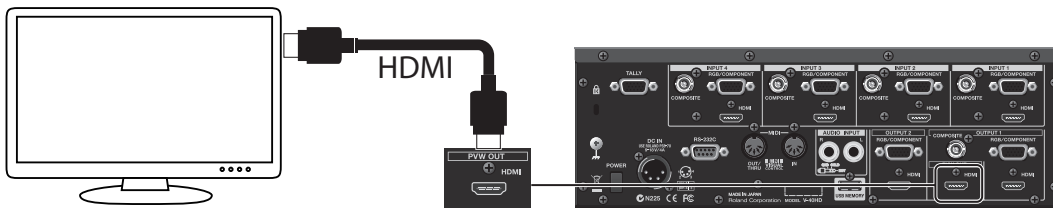

NOTE

The resolution and refresh rate of monitor output are fixed at 1920 x 1080/60 Hz (progressive). Connect a monitor that supports this resolution and refresh rate. Also, the monitor must support HDCP (High-bandwidth Digital Content Protection) signals. PVW Output shows blue screen when a non HDCP compliant monitor is connected, but Menu is in function.

About the View on the Preview Monitor

Use the PVW (Preview) selector on the top panel to choose the view displayed on the preview monitor.

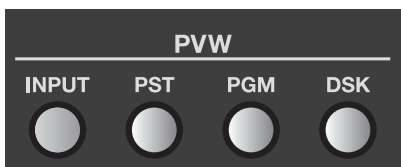

You can select one from the following four views to display.

INPUT	This displays the input source picture using a four-way split screen. (The display frame rate of the preview drops when this setting is used.)
PST	The picture of standby channel is displayed.
PGM	The picture on the current output channel is displayed.
DSK	This previews the status of DSK composition. Adjust the amount of keying in this mode.

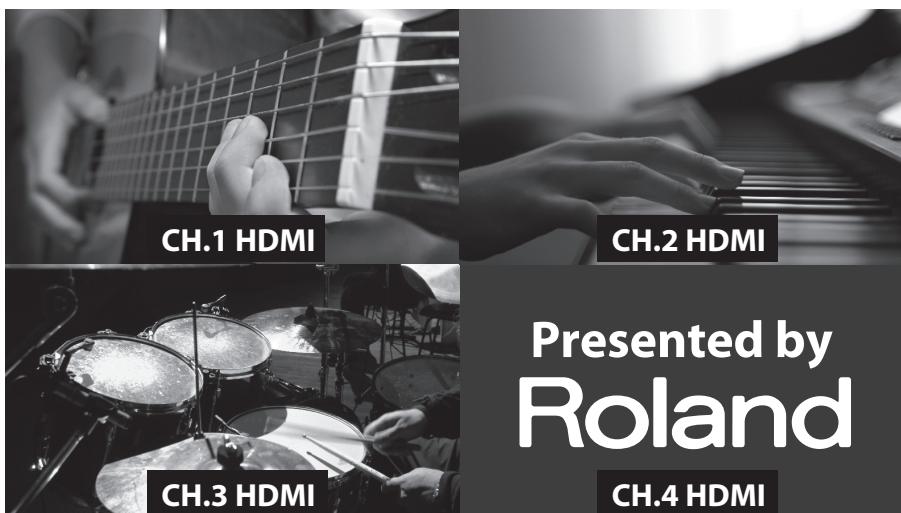

* When [INPUT] has been selected, a red border is displayed around the channel of current program output. A green border is displayed around the channel that is on standby.

* The input source pictures are displayed in the preview monitor directly (without any parameter changes). Settings such as color adjustment or scaling are not applied.

NOTE

When [INPUT] has been selected, the frame rate drops by about 5 fps. The frame rate does not fall when a setting other than [INPUT] is selected. When the source signal is interlace, the displayed image moves up and down for 1 line width.

MEMO

You can change the text labels for [CH 1] through [CH 4]. Refer to "Changing the Preview Labels" (p. 43).

About SD Source Preview

When the source is SD, the display does not use the entire screen. The display is as follows.



About the Menu Displays

Pressing the [MENU] button on the top panel displays the menu in the preview monitor. To make the displayed menu disappear, press the [EXIT] button on the top panel.

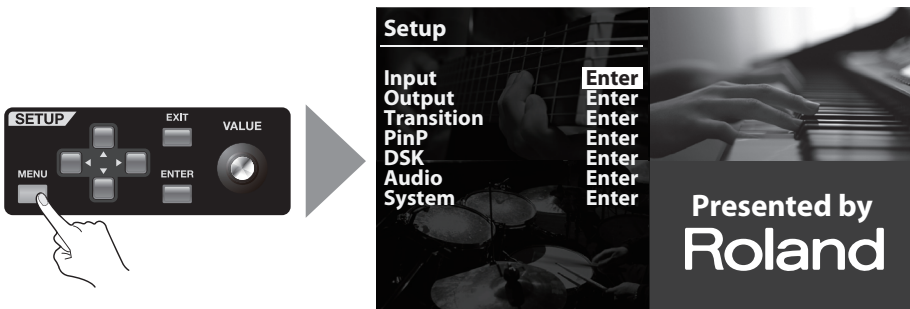

cf. →

For information on using the menus and on menu items, refer to "Menu Operations and Menu List" (p. 45).

About the Power Supply

Connecting the AC Adapter

Connect the AC adapter as shown in the figure below. Place the AC adaptor so the side with the indicator (see illustration) faces upwards and the side with textual information faces downwards.

* The indicator will light when you plug the AC adaptor into an AC outlet.

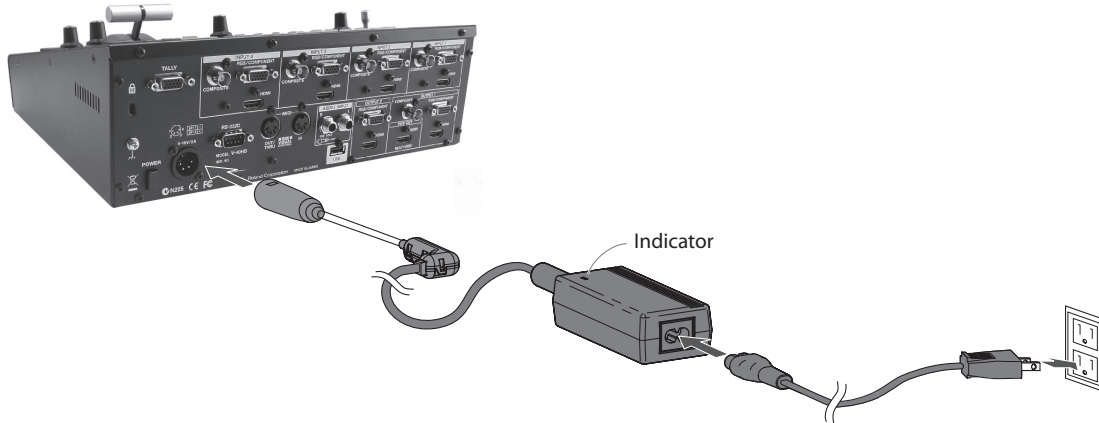

Caution Regarding the Power Supply

Depending on the circumstances of a particular setup, you may experience a discomforting sensation, or perceive that the surface feels gritty to the touch when you touch this device, video cameras connected to it, or the metal portions of other objects, such as monitors. This is due to an infinitesimal electrical charge, which is absolutely harmless. However, if you are concerned about this, connect the ground terminal (see figure) with an external ground. When the unit is grounded, a slight hum may occur, depending on the particulars of your installation. If you are unsure of the connection method, contact the nearest Roland Service Center, or an authorized Roland distributor, as listed on the "Information" sheet.

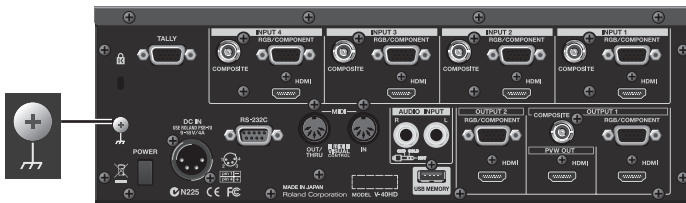

Unsuitable places for connection

- Water pipes (may result in shock or electrocution)
- Gas pipes (may result in fire or explosion)
- Telephone-line ground or lightning rod (may be dangerous in the event of lightning)

Important Notes on Installation

When installing the V-40HD, never block or place any objects against the ventilation holes. Doing so creates risk of a rise in the V-40HD's internal temperature and malfunction due to heat.

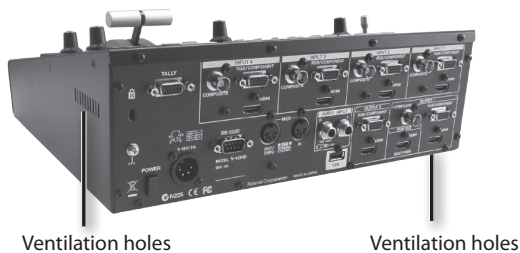

Turning the Power On and Off

Once everything is properly connected, be sure to follow the procedure below to turn on their power. If you turn on equipment in the wrong order, you risk causing malfunction or equipment failure.

* This unit is equipped with a protection circuit. A brief interval (a few seconds) after turning the unit on is required before it will operate normally.

Turning the Power On

1. Connect the peripheral devices.

Connect any video cameras and other equipment. Make the connections while the power to all equipment, including the V-40HD, is turned off.

2. Turn on the power to the V-40HD.

Make sure the power cable is securely inserted, then press the [POWER] button located on the rear panel. The buttons and indicators on the top panel flash, and the V-40HD starts up.

MEMO

When the V-40HD starts up, the settings saved at memory number 1 in bank 1 are loaded (p. 40).

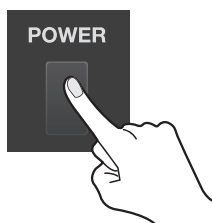

3. Turn on the power to the source devices.

Turn on the power to the source devices such as video cameras connected to the V-40HD.

4. Turn on the power to the output devices.

Turn on the power to the output devices such as projectors connected to the V-40HD.

Turning the Power Off

1. Turn off the power to the output devices.

Turn off the power to the output devices such as projectors connected to the V-40HD.

2. Turn off the power to the V-40HD.

Set the [POWER] switch on the rear panel to OFF to turn off the power to the V-40HD.

3. Turn off the power to the source devices.

Turn off the power to the source devices such as video cameras connected to the V-40HD.

NOTE

Never turn off the power while a message such as "Processing..." is shown in the menu display area of the preview monitor. Doing so might cause settings not to be saved properly.

About AUTO OFF

When all of the conditions described below continue for 240 minutes, the AUTO OFF feature automatically turns off the power to the V-40HD.

- No operation of the unit (including operation by remote control)
- No video input
- No audio input at -48 dBu or higher

NOTE

The settings you were editing will be lost when the unit is turned off. If you want to keep your settings, you must save your settings before turning the unit off.

MEMO

You can disable the AUTO OFF feature by going to the System menu and setting [AUTO OFF] to [OFF]. Refer to "Menu Operations" (p. 45) and "System Menu" (p. 49).

Part Names and Functions

Top Panel

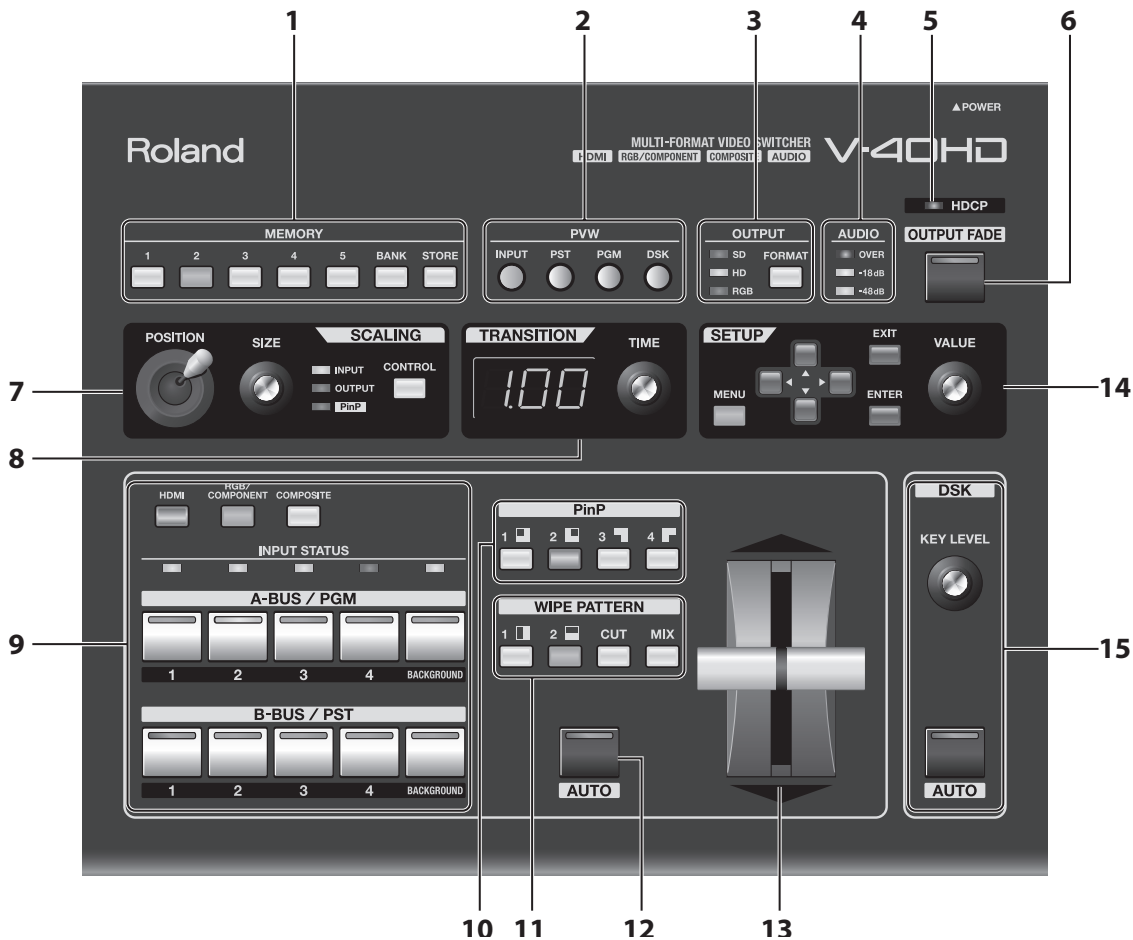

1. MEMORY Buttons

Use these to save the current settings to the internal memory (p. 40).

2. PVW (Preview) Selectors

These select the picture to output from the [PVW OUT] connector on the rear panel.

3. OUTPUT Selectors

Use the [FORMAT] button to switch the output format for OUTPUT 1 and 2.

* The format of PVW OUT cannot be changed.

4. AUDIO Indicators

These display the audio output level.

5. HDCP Indicator

This operates as described below, depending on the setting for HDCP signals (p. 26).

Lighted	It lights up when an HDCP-compatible device is connected as the output device.
Flashing	It flashes when no output device is connected or when the connected device is not compatible with HDCP.
Unlighted	It goes dark when the V-40HD's HDCP-signal input/output mode is off.

6. OUTPUT FADE Button

This applies fade to final output. The button flashes while the fade is in progress. The button lights up continuously when a fade-out has been completed. The button goes dark when a fade-in has been completed (p. 33).

* By default, the fade time is set at 0.5 seconds, and the fade goes to black. Use the menus (p. 50) to change the fade time and fade color.

7. SCALING Section

Use the controls in this section to zoom the screen in/out or adjust the display position. When you are applying Picture-in-Picture, use the controls in this section to adjust the size and display position of the inset screen.

8. TRANSITION Dial and Indicator

Use this dial to set the transition time.

* By default, the unit displays the transition time in seconds.. Use the menus (p. 48) to select a different unit (frames or seconds + frames).

9. Input Selectors

This has 5 buttons each in the A-BUS/PGM and B-BUS/PST sections. Use these to select the output video and standby video.

A-BUS/PGM	When you are making a selection while in the PGM/PST mode (p. 28), the button for the current output channel lights up red. When you are making a selection while in the A/B mode (p. 31), these choose the channel for A-Bus.
B-BUS/PST	When you are making a selection while in the PGM/PST mode, these choose the channel you want to output next (standby). When you are making a selection while in the A/B mode, these choose the channel for B-Bus.

Use the HDMI, RGB/COMPONENT, and COMPOSITE buttons to assign sources to each channel (p. 19). The lighted color and dark state of these buttons are switched as described below.

Red	This is the default. In this mode, assign a source after pressing a button (1 to 4) in the bus of current output.
Green	In this mode, assign a source after pressing a button (1 to 4) in the bus of standby.
Orange	The button lights up orange when sharing a source (p. 21).
Unlighted	In this mode, sources cannot be assigned using the HDMI, RGB/COMPONENT, and COMPOSITE buttons.

The [INPUT STATUS] indicators light up when the assignment and the input match. They do not light up when the assignment and input are different.

10. PinP Selectors

Pressing one of the buttons from 1 to 4 applies picture-in-picture.

11. WIPE PATTERN Selectors

These select a transition effect.

* Use the menus to assign other wipe patterns to the WIPE 1 and 2 buttons.

12. AUTO Button

Pressing this button outputs the standby channel. Pressing this button applies the effect selected using the [WIPE PATTERN] buttons, for the time set using the [TRANSITION] dial.

13. Video Fader

Use this to apply a transition manually. When the transition is made manually, the time for the transition effect changes depending on the movement of the video fader, regardless of the setting made using the [TRANSITION] dial.

14. SETUP Section

Use this when displaying the menu screen to change settings on the V-40HD (p. 45).

15. DSK Section

When performing DSK composition, pressing the [AUTO] button in this section to make the DSK source (foreground video) appear or disappear. Also adjust the amount of keying by turning the [KEY LEVEL] dial (p. 35).

* By default, the setting is to apply black extraction. Use the menus (p. 49) to change the settings.

Rear Panel

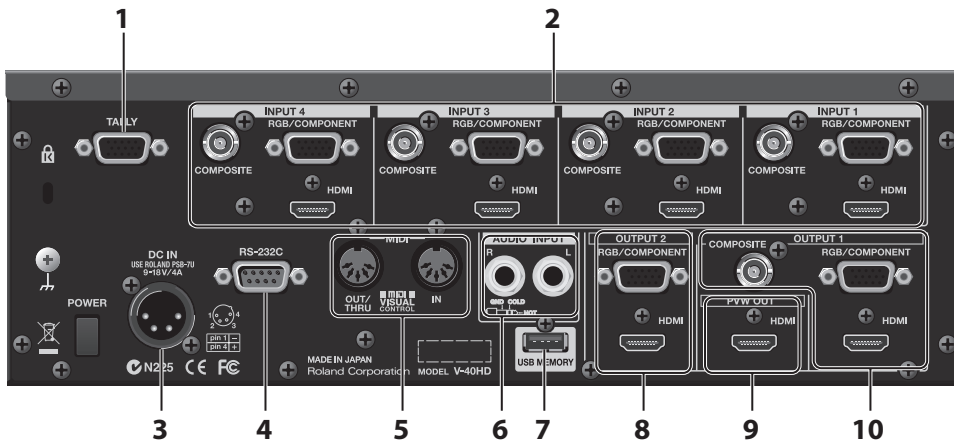

1. TALLY Connectors

Connect devices provided with a tally-light feature (p. 23).

2. INPUT Connectors 1 - 4

Connect video sources. Sections 1 through 4 are each provided with the connection terminals described below, and use the buttons or menu to select the connector to enable.

* By default, HDMI input is enabled for each channel.

COMPOSITE	Connect equipment capable of composite output, such as a video camera or DVD player.
RGB/COMPONENT	Connect a computer or other source equipment capable of analog RGB output. By using a conversion cable for component to mini D-Sub 15-pin type, you can also connect equipment capable of Y/Pb/Pr component output.
HDMI	Connect a video camera or other source equipment capable of HDMI output. When connecting a Blu-ray Disc player or other device that outputs signals to which HDCP is applied, refer to "Inputting HDCP Signals" (p. 26).

3. DC IN Connector

This is for connecting the included AC adapter (p. 12).

4. RS-232C Connector

Use this when using an external device to operate the unit by remote control. Refer to "About Remote Control" (p. 53).

5. MIDI Connectors

Use these when remotely controlling the unit from an external MIDI device (a device compatible with MIDI VISUAL CONTROL or the like), or when using the unit to perform remote control of another device. Refer to "About Remote Control" (p. 53).

6. AUDIO INPUT Connectors

The V-40HD can output video and audio together from the HDMI connectors. Use these AUDIO INPUT connectors to connect source equipment for analog audio.

7. USB MEMORY Connector

This is for connecting a USB memory device for copying data saved in internal memory.

* Never eject or insert a USB memory device while the V-40HD is powered up. Doing so might cause loss of data in the V-40HD or on the USB memory device.

* Be careful to orient the USB memory device correctly front and back and in the correct direction for insertion, and insert it firmly, as far as it will go. Never insert using undue force.

8. OUTPUT 2 Connectors

Connect a projector or recording equipment. RGB/COMPONENT and HDMI output connectors are provided.

9. PVW OUT Connector

Connect a monitor for preview output (p. 10).

10. OUTPUT 1 Connectors

Connect a projector or recording equipment. In addition to the RGB/COMPONENT and HDMI output connectors, a COMPOSITE output connector is provided.

Connecting External Equipment

Connect external equipment as shown in this chapter. For information on specific connection methods, refer to the following pages.

* To prevent malfunction and equipment failure, always turn down the volume, and turn off all the units before making any connections.

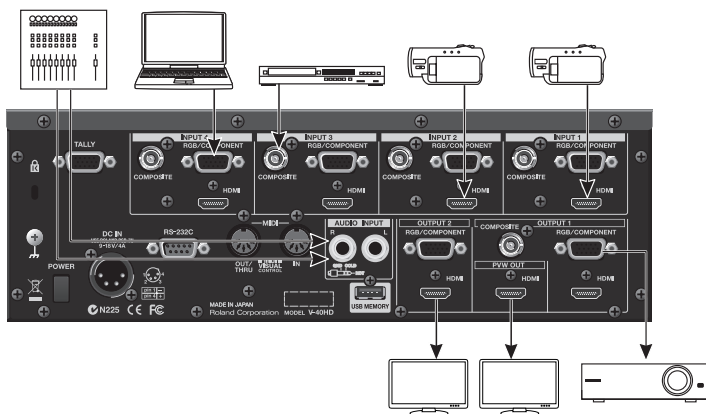

For information on signal formats that can be input and output, refer to “About Input/Output Formats” (p. 24).

Signal Flow

The internal signal flow of the V-40HD is as shown below.

Video Signals

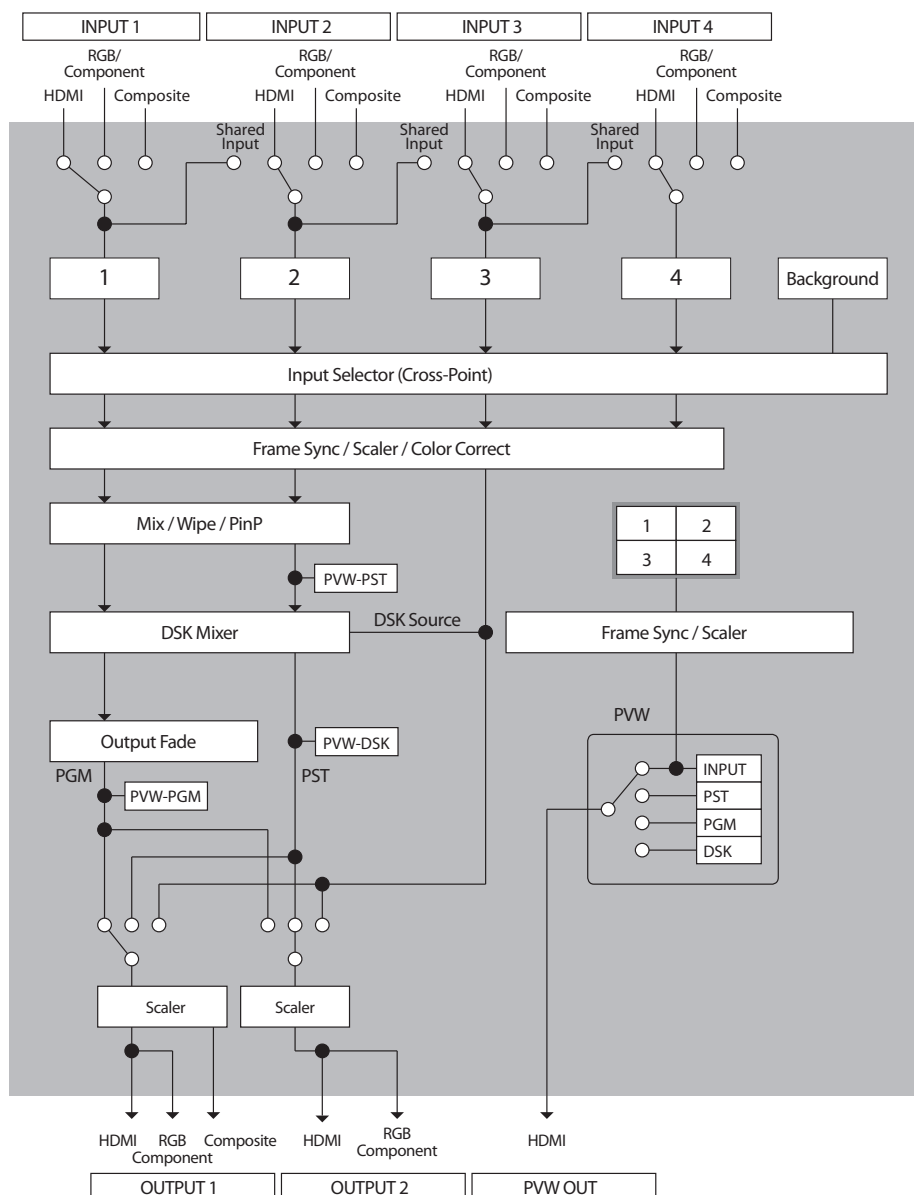

Audio Signals

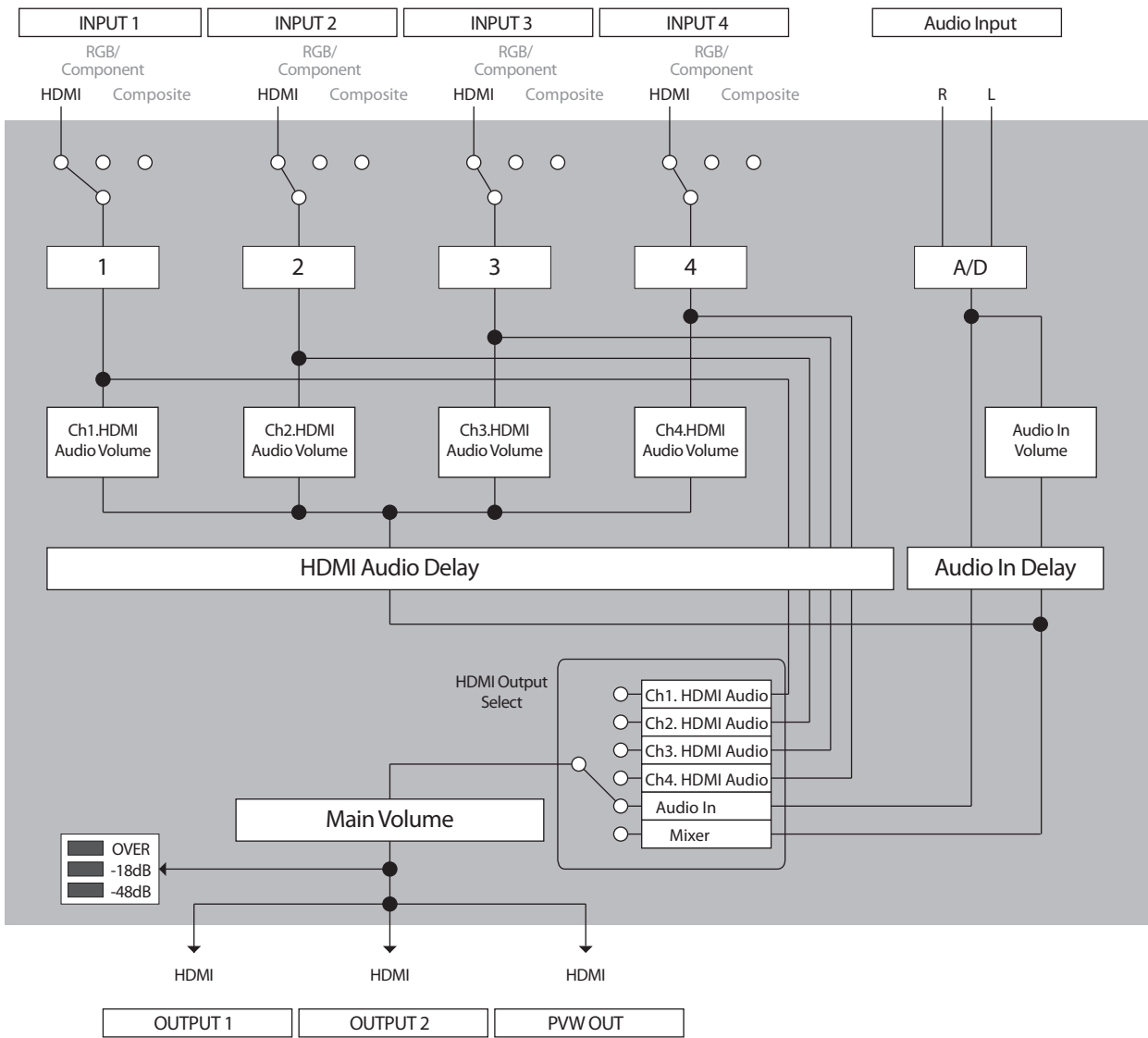

* When you attempt to input HDMI audio, assign HDMI inputs to channels.

Connecting Source Equipment

Connecting Video Sources

MEMO

Use the menus to assign sources to channels instead of using the button operations described below. Select a channel (Ch. 1 - Ch. 4) in the Input menu (p. 46), then select the source to assign.

Making an HDMI Connection

Connect video cameras or other devices capable of HDMI output to the HDMI connectors at INPUT 1 through 4.

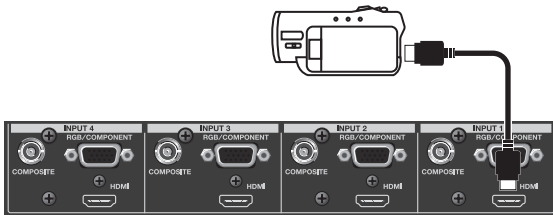

To assign HDMI input to channel 1, go to [A-BUS/PGM] and press [1], then press the [HDMI] button. When the V-40HD detects the HDMI input, the [INPUT STATUS] indicator of the channel 1 lights up.

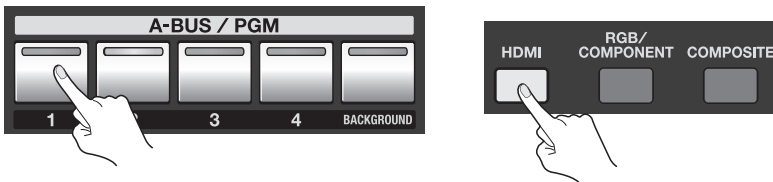

MEMO

To connect a computer capable of DVI output, use a DVI - HDMI conversion cable to make the connection to an HDMI connector.

Making an RGB Connection

Connect computers or other devices capable of RGB output to the RGB/COMPONENT connectors at INPUT 1 through 4.

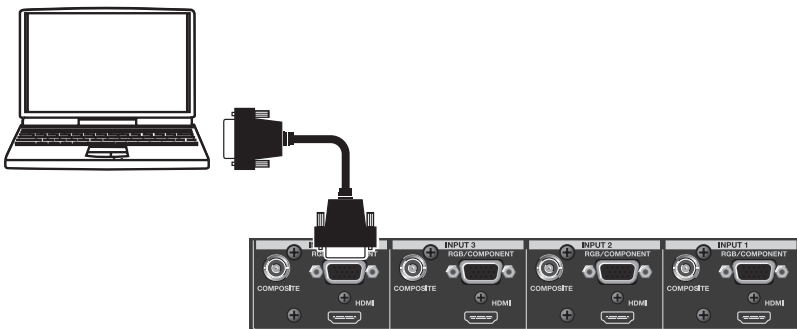

To assign RGB input to channel 4, go to [A-BUS/PGM] and press [4], then press the [RGB/COMPONENT] button. When the V-40HD detects the RGB input, the [INPUT STATUS] indicator of the channel 4 lights up.

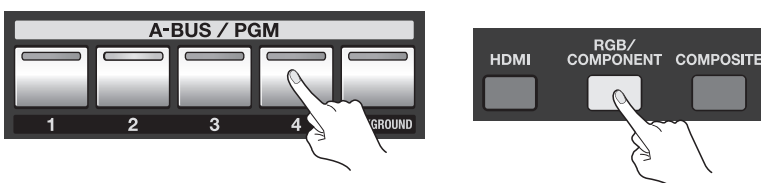

Connecting External Equipment

Making a Component Connection

Connect video cameras or other devices capable of component output to the RGB/COMPONENT connectors at INPUT 1 through 4. When doing this, use a conversion cable for component to mini D-Sub 15-pin type.

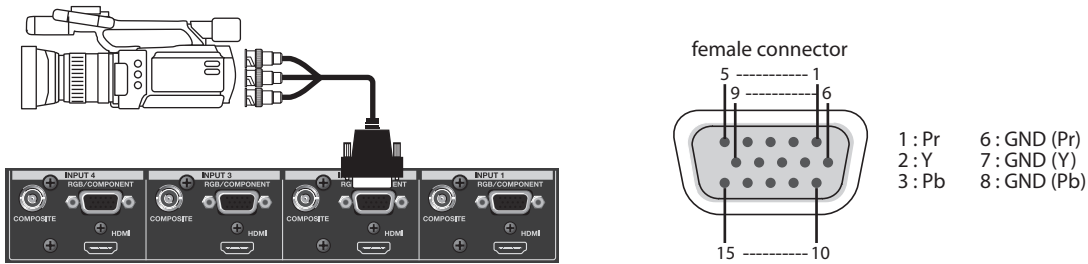

To assign component input to channel 2, go to [A-BUS/PGM] and press [2], then press the [RGB/COMPONENT] button. When the V-40HD detects the component input, the [INPUT STATUS] indicator of the channel 2 lights up.

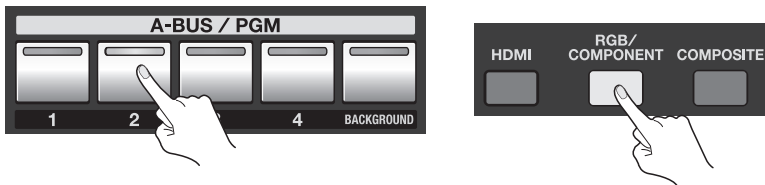

Making a Composite Connection

Connect video cameras, DVD players, or other devices capable of composite output to the COMPOSITE connectors at INPUT 1 through 4.

* When connecting equipment that has an RCA type output jack, use the included RCA - BNC conversion plug.

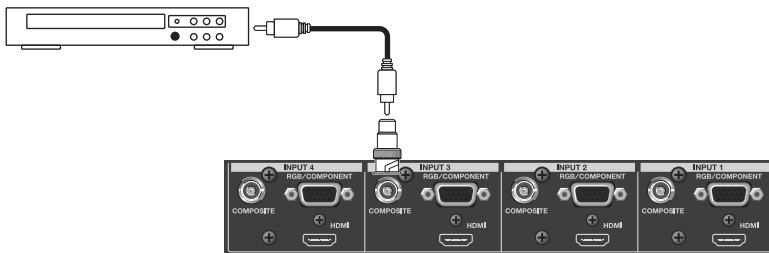

To assign composite input to channel 3, go to [A-BUS/PGM] and press [3], then press the [COMPOSITE] button. When the V-40HD detects the composite input, the [INPUT STATUS] indicator of the channel 3 lights up.

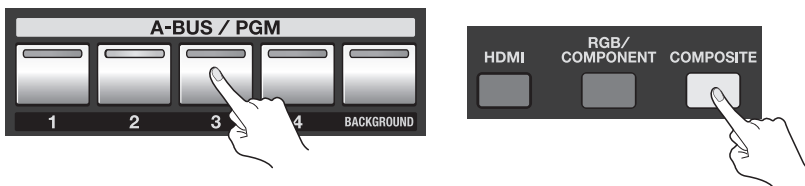

MEMO

By default, [1] through [4] in the current output bus are used to assign input sources. Changing the mode lets you perform these operations using the buttons in the standby bus. You can also disable (set to OFF) operation of the [HDMI], [RGB/COMPONENT], and [COMPOSITE] buttons. Go to the System menu (p. 49) and use [Source Assign Mode] to make the changes.

Connecting Audio Sources

Connect audio mixers or other audio sources to the AUDIO INPUT connectors. Input made via these connectors is output from HDMI connectors in the OUTPUT 1/2 sections together with the results of video mixing on the V-40HD.

* When connection cables with resistors are used, the volume level of equipment connected to the inputs (AUDIO INPUT) may be low. If this happens, use connection cables that do not contain resistors.

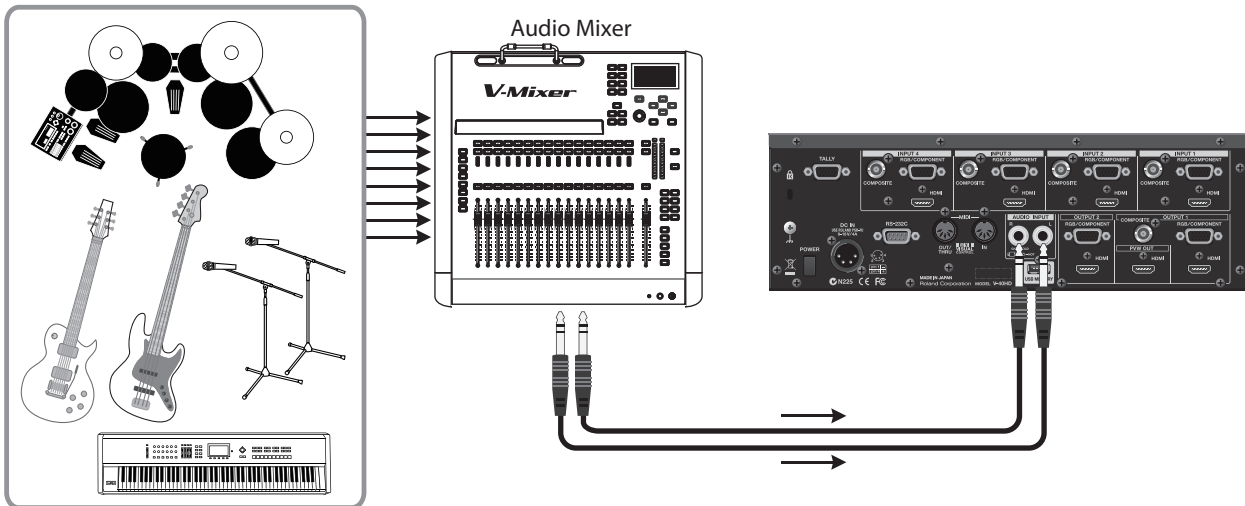

NOTE

This unit is equipped with balanced (TRS) type jacks. Wiring diagrams for these jacks are shown below. Make connections after first checking the wiring diagrams of other equipment you intend to connect.



MEMO

Use the menus to adjust the audio level (p. 37) or delay its timing to sync it with the video (p. 38).

Sharing a Source Between Channels

Channels 1 through 4 can share a source. Using this feature, you can assign the video on channel 1 to channels 2 through 4. When shared, a single source video is assigned to multiple channels. To share a source, go to the Input menu (p. 45) and select [Shared Input] in the input format display area.

* Only the source of the previous adjacent channel can be shared. Therefore, when sharing the source on channel 1 with channels 2 through 4, [Shared Input] must be selected for each channel from 2 to 4.

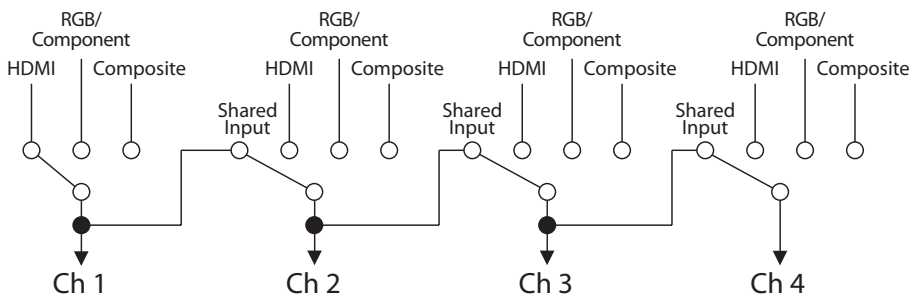

NOTE

Audio sources cannot be shared.

Connecting Output Equipment

For information on the signal formats that can be output from the V-40HD, refer to “About Input/Output Formats” (p. 24).

Connecting a Projector or Recording Unit

Make the connection to the connector in OUTPUT 1 or 2 sections.

* The output format is common for both OUTPUT 1 and 2.

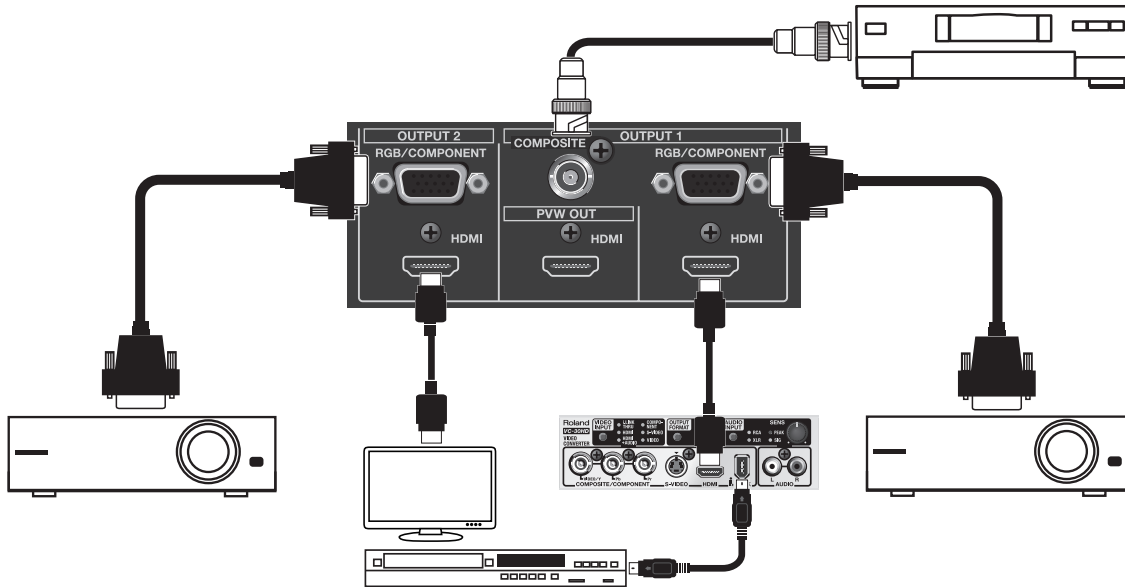

TIP

You can connect HDMI output via a VC-30HD to the i.LINK input on a digital video recorder, Blu-ray Disc recorder, or other such device.

MEMO

You can select separate output buses for OUTPUT 1 and 2. You can also select separate output formats as well. Refer to “Output Menu” (p. 46).

NOTE

- When HDMI outputs from any HDMI devices are connected to the OUTPUT 1/2 or the PVW OUT by mistake, the V-40HD may not boot up.
- When HDCP is set to ON (p. 26), output is made only from the HDMI output connectors. Output from other connectors is stopped.

Connecting Tally-capable Equipment

The V-40HD is equipped with a D-Sub 15-pin TALLY connector. Connecting a video monitor capable of tally input to this makes it possible to illuminate the tally lamps on the monitor. The lamp is switched on and off according to the channel selection, enabling you to see which channel is currently in use on the monitor.

The specifications of the TALLY connector on the V-40HD is as follows.

- Mini D-Sub 15-pin type
- Maximum input: 12V/200 mA
- Open-collector type

The channels shown below are assigned to the TALLY connector on the V-40HD.

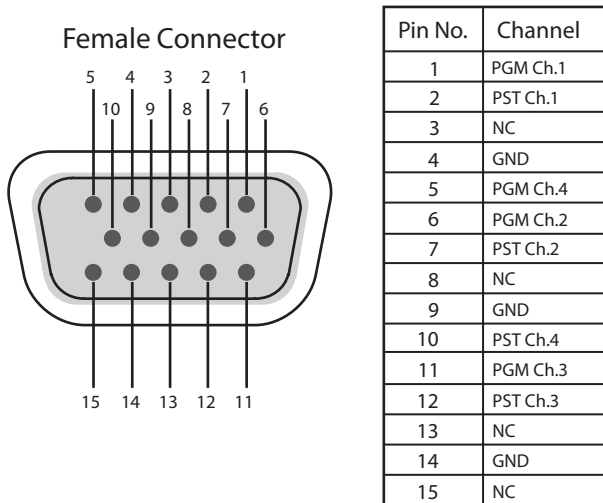

About Input/Output Formats

Input Formats

It is possible to input signal of various formats to INPUT 1-4 of the V-40HD.

Signals of the following formats can be input. The input format is detected automatically.

Frame Rate	59.94 Hz	50 Hz
COMPOSITE	NTSC)	PAL
COMPONENT	480/59.94i, 480/59.94p, 720/59.94p, 1080/59.94i, 1080/59.94p	576/50i, 576/50p, 720/50p, 1080/50i, 1080/50p
RGB	640 x 480/60 Hz, 800 x 600/60 Hz, 1024 x 768/60 Hz, 1280 x 768/60 Hz, 1280 x 1024/60 Hz, 1366 x 768/60 Hz, 1400 x 1050/60 Hz, 1600 x 1200/60 Hz, 1920 x 1080/60 Hz, 1920 x 1200/60 Hz (Reduced Blanking)	
HDMI	480/59.94i, 480/59.94p, 720/59.94p, 1080/59.94i, 1080/59.94p	576/50i, 576/50p, 720/50p, 1080/50i, 1080/50p
	640 x 480/60 Hz, 800 x 600/60 Hz, 1024 x 768/60 Hz, 1280 x 768/60 Hz, 1280 x 1024/60 Hz, 1366 x 768/60 Hz, 1400 x 1050/60 Hz, 1600 x 1200/60 Hz, 1920 x 1080/60 Hz, 1920 x 1200/60 Hz (Reduced Blanking)	

* HDMI audio input format is Linear PCM, 24 bits/48 kHz, 2ch.

Using the Menus to Set the Output Format for OUTPUT 1/2

You can use the menus to set the output format for OUTPUT 1 and 2.

* The output signal format of the COMPOSITE connector in OUTPUT 1 is NTSC or PAL. A common format is output from the HDMI and RGB/COMPONENT connectors in OUTPUT 1/2.

1. Display the Output menu.

Press the [MENU] button to display the menu. Use the [CURSOR] buttons to select [Output], then press the [ENTER] button to display the Output menu.

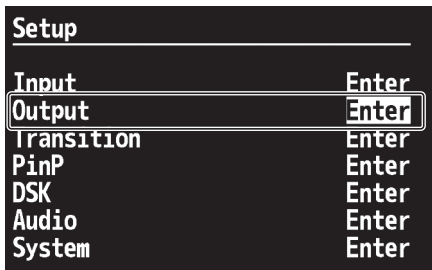

2. Set the output format.

Turn the [VALUE] dial to set the output format.

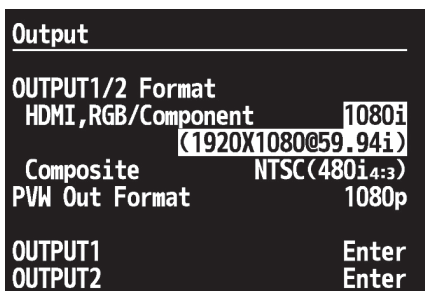

MEMO

You can independently set various parameters for OUTPUT 1 and 2. Refer to Output menu (p. 46).

NOTE

If one of below is selected as the output format, signal output from the RGB/COMPONENT connector is disabled.

- 480/59.94i (NTSC)
- 576/50i (PAL)
- 1080/59.94i
- 1080/50i

Using the Buttons to Change the Output Format for OUTPUT 1/2

Use the OUTPUT selectors on the top panel to change the output format. Press the [FORMAT] button to change the illuminated indicator.

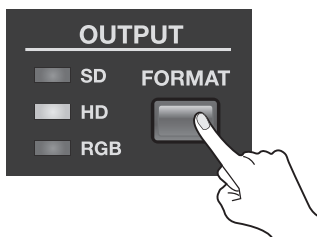

By default, the following signals are output. The signal format that is output changes according to the setting described in the previous section.

Frame Rate	59.94 Hz	50 Hz
SD	NTSC	PAL
HD	1080/59.94i	1080/50i
RGB	1024 x 768/60 Hz	1024 x 768/75 Hz

Output Formats from the Connectors

Signals in the following formats can be output from the respective output connectors on the V-40HD. Refer to Output Menu (p. 46).

OUTPUT 1/2

Frame Rate	59.94 Hz	50 Hz
COMPOSITE (*1)(*2)	NTSC	PAL
COMPONENT (*2)	480/59.94p, 720/59.94p, 1080/59.94p	576/50p, 720/50p, 1080/50p
RGB (*2)	640 x 480/60 Hz, 800 x 600/60 Hz, 1024 x 768/60 Hz, 1280 x 768/60 Hz, 1280 x 1024/60 Hz, 1366 x 768/60 Hz, 1400 x 1050/60 Hz, 1600 x 1200/60 Hz, 1920 x 1200/60 Hz (Reduced Blanking)	640 x 480/75 Hz, 800 x 600/75 Hz, 1024 x 768/75 Hz, 1280 x 768/75 Hz, 1280 x 1024/75 Hz, 1366 x 768/75 Hz, 1400 x 1050/75 Hz, 1600 x 1200/60 Hz, 1920 x 1200/60 Hz (Reduced Blanking)
HDMI	480/59.94i, 480/59.94p, 720/59.94p, 1080/59.94i, 1080/59.94p 640 x 480/60 Hz, 800 x 600/60 Hz, 1024 x 768/60 Hz, 1280 x 768/60 Hz, 1280 x 1024/60 Hz, 1366 x 768/60 Hz, 1400 x 1050/60 Hz, 1600 x 1200/60 Hz, 1920 x 1200/60 Hz (Reduced Blanking)	576/50i, 576/50p, 720/50p, 1080/50i, 1080/50p 640 x 480/75 Hz, 800 x 600/75 Hz, 1024 x 768/75 Hz, 1280 x 768/75 Hz, 1280 x 1024/75 Hz, 1366 x 768/75 Hz, 1400 x 1050/75 Hz, 1600 x 1200/60 Hz, 1920 x 1200/60 Hz (Reduced Blanking)

*1 : OUTPUT 1 only

*2 : No output while the HDCP setting is ON (p. 26).

PVW OUT

Frame Rate	59.94 Hz	50 Hz
HDMI	1920 x 1080/60 Hz	

* HDMI audio output format of OUTPUT 1/2 and PVW OUT is Linear PCM, 24 bits/48 kHz, 2ch.

Inputting HDCP Signals

By default, the HDCP (High-bandwidth Digital Content Protection) setting of the V-40HD is turned off. This means that HDCP-applied signals from Blu-ray Disc players and the like cannot be input. When inputting signals to which HDCP is applied, follow the procedure shown below to change the setting.

* HDCP is copyright-protection technology that prevents unlawful copying of content by encoding the path when sending digital signals from a video playback device to a display monitor or other display equipment.

1. Display the System menu.

Press the [MENU] button to display the menu. Use the [CURSOR] buttons to select [System], then press the [ENTER] button to display the System menu.

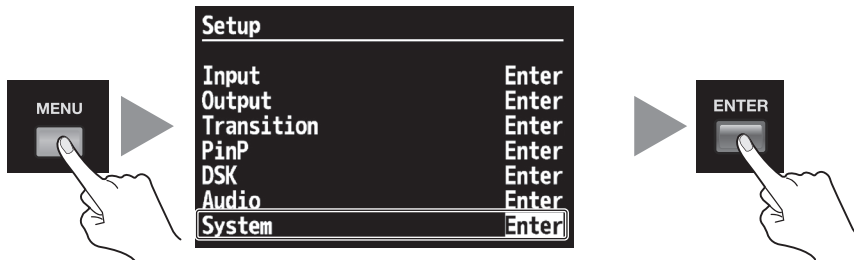

2. Change the setting.

Use the [CURSOR] buttons to select [HDCP]. Turn the [VALUE] dial to change the setting from [OFF] to [ON]. When the confirmation screen appears, press the [ENTER] button.

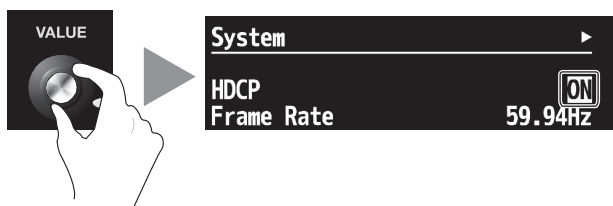

3. Exit the menu.

Press the [EXIT] button several times to quit the menu.

NOTE

When the setting change just described has been made, no further output is made from the COMPOSITE and RGB/COMPONENT connectors in OUTPUT 1 and 2. Note, however, that HDCP-applied signals are output from the HDMI connectors.

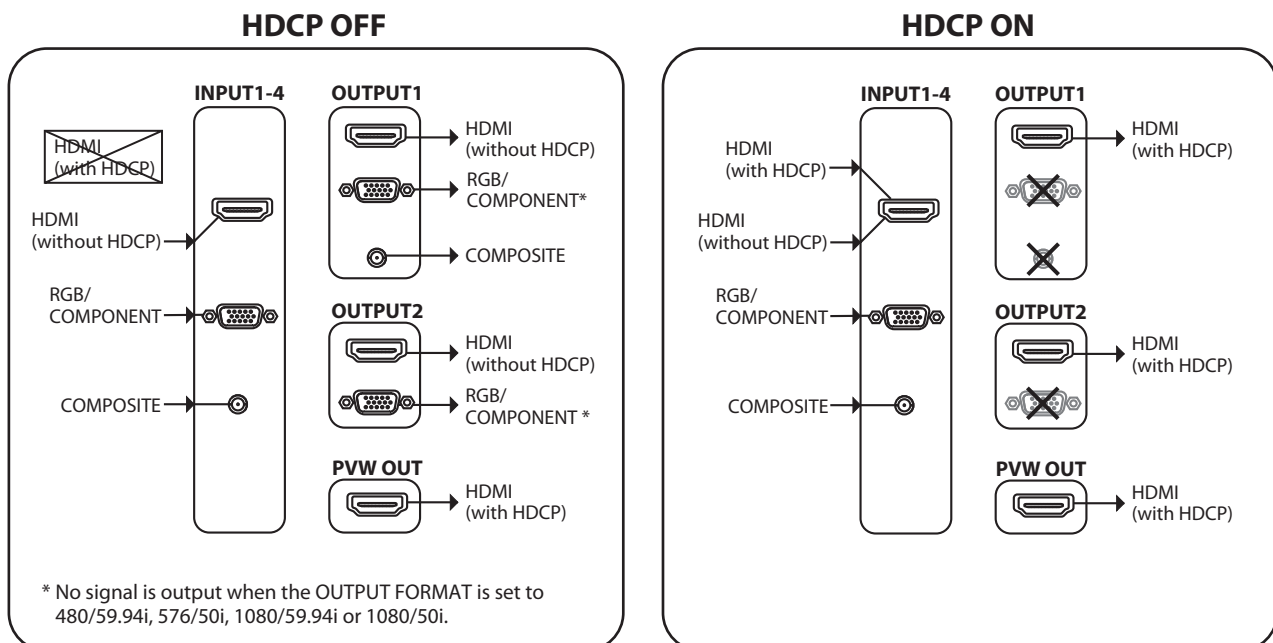

About the HDCP Indicator

The [HDCP] indicator on the top panel operates as described below.



Lighted	Turn on the HDCP setting and HDCP-compatible device(s) is connected to any of the HDMI connectors of OUTPUT 1/2 or PVW OUT.
Flashing	Turn on the HDCP setting but no device is connected to any of the HDMI connectors of OUTPUT 1/2 or PVW OUT. Same thing happens when a device not compatible with HDCP is connected.
Unlighted	The HDCP setting is turned off.

* The above operation is not related to inputs, detected from devices connected to output connectors only.

About Verification of HDCP-compatible Equipment

You can examine the HDCP compatibility of source equipment and output equipment. Open Input menu or Output menu. You can see [HDCP] indications like below if the connected devices are compatible.

Input ENTER

Ch.1  1920x1080@59.94i

Ch.2 1024x 768@60.00p
RGB/Component

Ch.3  1920x1080@59.94p
HDMI

Ch.4 1280x 720@59.94p
HDMI

Background R: 16 G: 16 B: 16

Output

OUTPUT1/2 Format
HDMI,RGB/Component 1080i
(1920X1080@59.94i)

Composite NTSC(480i4:3)

PVW Out Format 1080p

OUTPUT1  Enter

OUTPUT2  Enter

Composite Enter

PVW Output  Enter

Basic Operations

NOTE

Using this unit makes it possible to create video transitions that occur at extremely high speeds. Depending on physical condition, viewing such video might cause headache or discomfort. Never use this unit to create or present such video that might be distressful to health. Roland assumes no responsibility in the event of any distress experienced by you or other viewers.

Checking the Currently Selected Channels

Before you carry out a transition, check which channels are currently selected. Immediately after turning the V-40HD on, MEMORY 1-1 (No. 1 in bank 1) is selected. The channels in the panel state saved at 1-1 are selected.

* For information on saving data to MEMORY buttons, refer to "Saving/Recalling Settings" (p. 40).

In the [INPUT] mode of the preview monitor, a red border is displayed around the video currently being output, and a green border is displayed around the video on standby.

At the [A-BUS/PGM] input selectors, the button for the channel currently being output lights up red. At [B-BUS/PST], the button for the channel currently on standby lights up green.

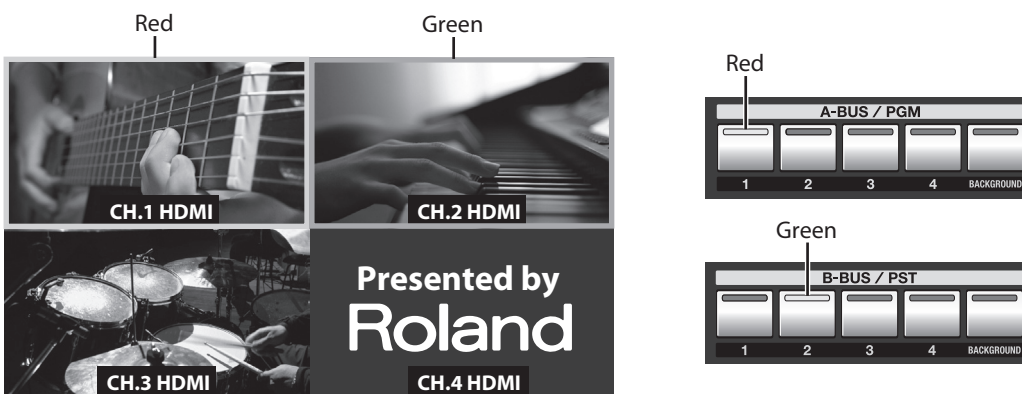

Switching Video in the PGM/PST Mode

The default operation mode of the V-40HD is the PGM/PST mode. You can also select the A/B mode (p. 31).

Switching the Video Using Buttons

Use the [AUTO] button to switch the video. The effect selected using the [WIPE PATTERN] buttons is applied for the time set using the [TRANSITION] dial.

1. Move the video fader all the way.

Move the video fader all the way toward either the front or the back.

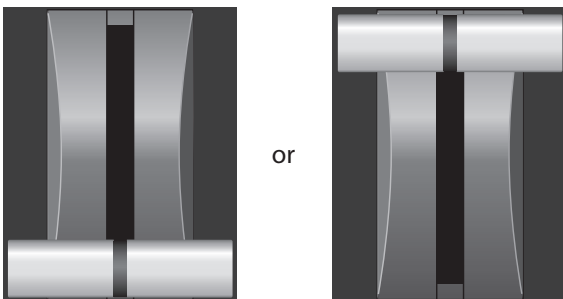

2. Select a transition effect.

Use the [WIPE PATTERN] buttons to select the transition effect you want to apply.

* Using the [CUT] button makes the video change instantly, with no transition effect applied.

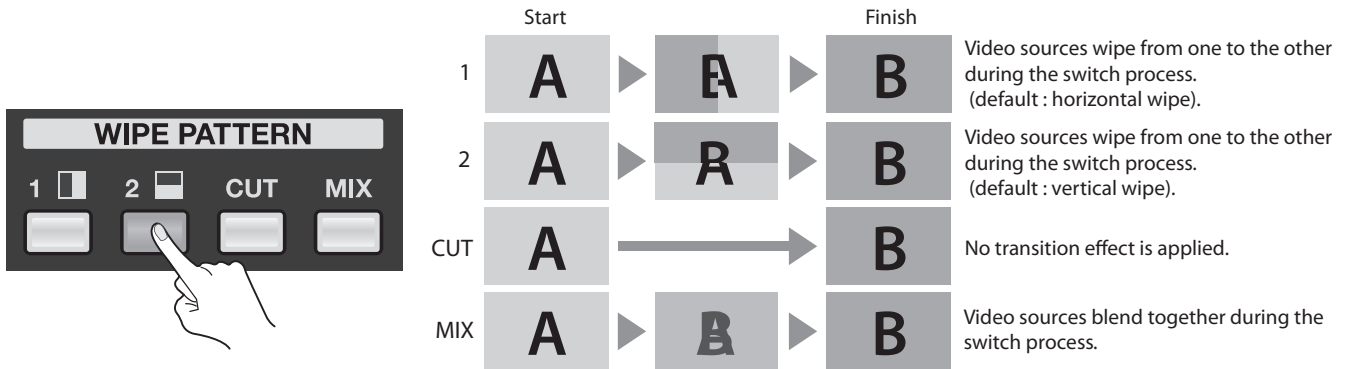

3. Set the transition time.

Operate the [TRANSITION] dial to set the time for which the transition effect is applied.

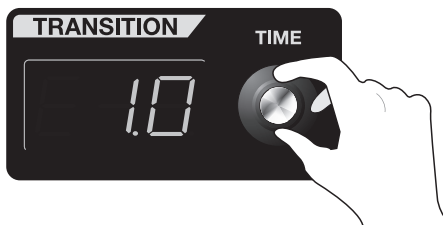

4. Select the video you want to output next.

Use the input selectors in the [B-BUS/PST] section to select the channel of the video you want to output next (standby). The indicator for the pressed button lights up green. In the [INPUT] mode of the preview monitor, a green border is displayed around the selected channel.

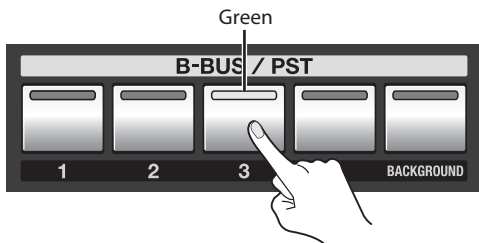

5. Output the selected video.

Press the [AUTO] button. The final output changes to the video on the channel selected in step 4.

* When a [WIPE PATTERN] button other than [CUT] has been selected, the [AUTO] button indicator flashes while the transition effect is applied.



When the transition is complete, the input selector in the [A-BUS/PGM] section for the channel selected in step 4 lights up red.

Also, in the [INPUT] mode for the preview monitor, a red border is displayed around the video on that channel.

The channel that was output before the [AUTO] button was pressed changes to the standby channel at this time.

While the transition is in progress (that is, while the transition effect is being applied), the [AUTO] button indicator flashes.

Switching the Video Directly

It is also possible to directly switch the video pressing the buttons in [A-BUS/PGM] section. However, a short black image is inserted between 2 video images on the conditions below.

- When a direct switching operation is carried out while a logo/text is composited using the DSK function (p. 35).
- [DSK] is selected as the display mode of preview monitor and [PST] is selected as the output source for OUTPUT 1/2.
- [DSK] is selected as the output source for OUTPUT 1/2.

Switching the Video Using the Video Fader

When you use the [AUTO] button, the transition effect is applied for the time set using the [TRANSITION] dial. When you use the video fader to perform a transition, you can control the length of the transition time manually.

1. Move the video fader all the way.

Before you carry out a transition operation, move the video fader all the way toward either the front or the back.

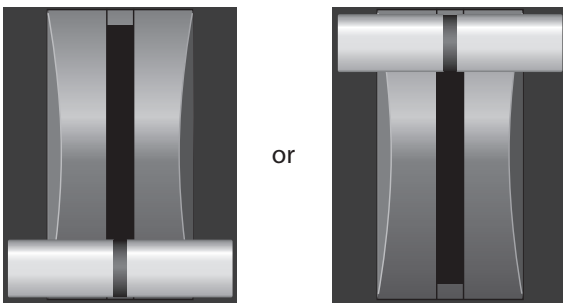

2. Select a transition effect.

Use the [WIPE PATTERN] buttons to select the transition effect you want to apply.

* If you select [CUT], the transition occurs when the video fader is at its center position.

3. Select the channel you want to output next.

Use the input selectors in the [B-BUS/PST] section to select the channel of the video you want to output next (standby).

4. Switch the output video.

Move the video fader in the opposite direction of step 1. Moving it all the way makes the final output switch to the video on the channel selected in step 3.

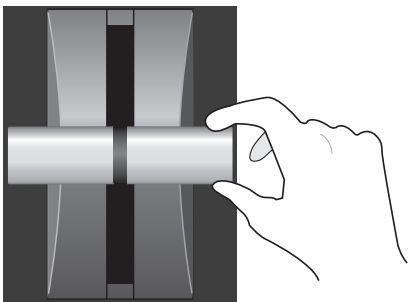

Switching in the A/B Mode

Changing the Operation Mode

For information on using the menus, also refer to “Menu Operations and Menu List” (p. 45).

1. Display the System menu.

Press the [MENU] button to display the menu. Use the [CURSOR] buttons to select [System], then press the [ENTER] button to display the System menu.

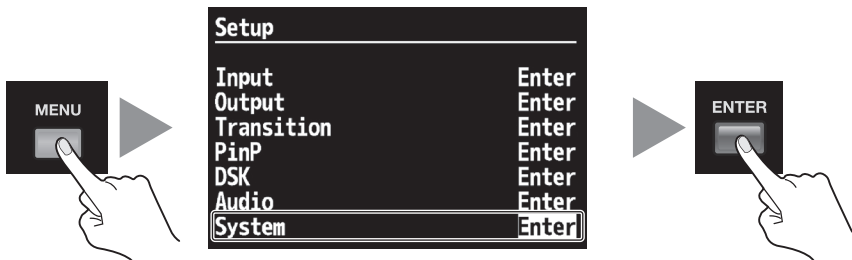

2. Select [Panel Mode].

Use the [CURSOR] buttons to select [Panel Mode].

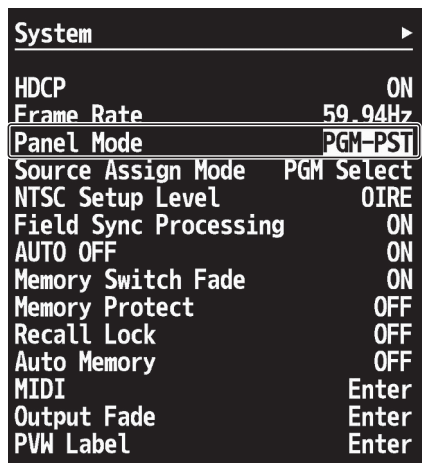

3. Select [A/B Mode].

Turn the [VALUE] dial to select [A/B].



4. Exit the menu.

Press the [EXIT] button several times to quit the menu.

Switching in the A/B Mode

1. Select the A-Bus and B-Bus video.

Select the channels for A-Bus and B-Bus. Selecting a channel makes the button indicator light up red or green.

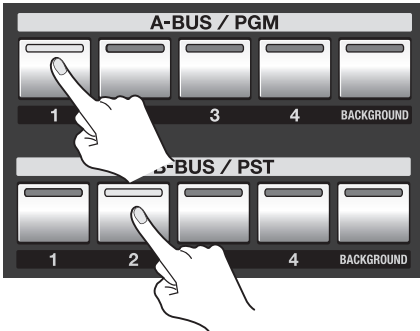

2. Select a transition effect.

Use the [WIPE PATTERN] buttons to select the transition effect you want to apply.

3. Move the video fader.

Move the video fader. Moving the fader toward the rear displays the A-Bus video, and moving it back toward the front displays the B-Bus video.

* If you select [CUT] in step 2, the A-Bus and B-Bus video are switched at the center position.

* If you select the same channel for A-Bus and B-Bus, the video is not switched even if you move the video fader.

NOTE

When the video fader has not been moved all the way and the channel for the opposite bus is switched, the video output to the preview monitor might be corrupt. When changing the input, first make sure that the video fader has been moved all the way to the end of the stroke.

About the Indicator Color

Pressing an input-selector button makes the indicator light up either red or green. The color varies according to the position of the video fader. At the end of the stroke (during 100% output) the indicator lights up red, and at the opposite end of the stroke (during standby = no output at all) it lights up green. When the control is not completed at one of these ends, both light up red.

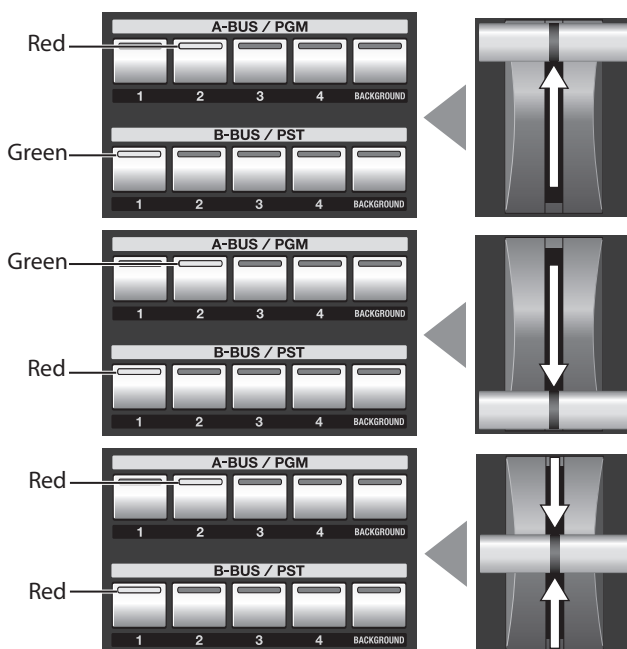

MEMO

However, while you are compositing 2 pictures using PinP (p. 34), the channel for inset screen light up in orange.

Applying Fade to Final Output

Use the [OUTPUT FADE] button to apply a fade to the final output of the V-40HD. Applying a fade makes the output video gradually disappear (fade-out) or appear (fade-in).

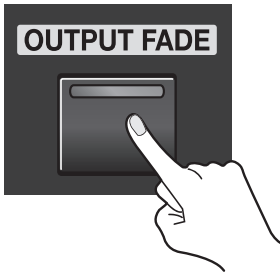

1. Apply a fade-out.

Press the [OUTPUT FADE] button to start fade-out. The button indicator flashes while the fade is in progress. When the fade-out has been completed, the indicator stops flashing and stays lighted.

2. Apply a fade-in.

Press the [OUTPUT FADE] button again to start fade-in. When the fade-in has been completed, the indicator goes dark.

MEMO

By default, the fade time is set to 0.5 seconds and the fade color is set to black. If you want to change the settings by using the menus, refer to "Menu Operations and Menu List" (p. 45).

Compositing the Video

Compositing Using Picture-in-Picture

This composites an inset screen into background video. Here below is the procedure to composite in PGM/PST mode.

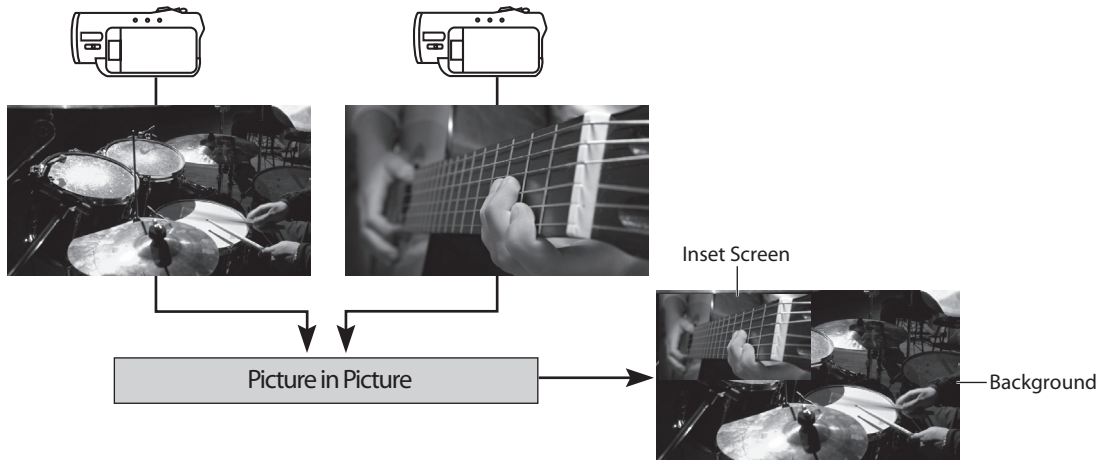

1. Select the background channel.

Use the buttons (1 through 4) in the [A-BUS/PGM] section to select the background channel.

* If you want to use a plain colored background, select [BACKGROUND] in the [A-BUS/PGM] section. The default setting is black.

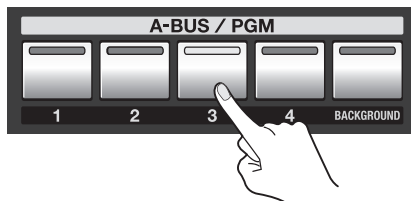

2. Select the channel of the inset screen.

Use the buttons (1 through 4) in the [B-BUS/PST] section of input selectors to select the channel of the inset screen.

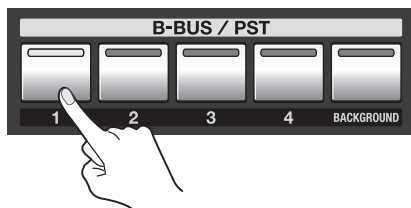

3. Preview the results of compositing.

Press one of the PinP selector buttons (1 through 4). The pressed button lights up in green. Pressing the button lets you preview the results of compositing. Select the [PST] in PVW selector displays a preview of the composition on the preview monitor.

* At this stage, the composition result is only output to the preview monitor. The final output has not yet been changed.

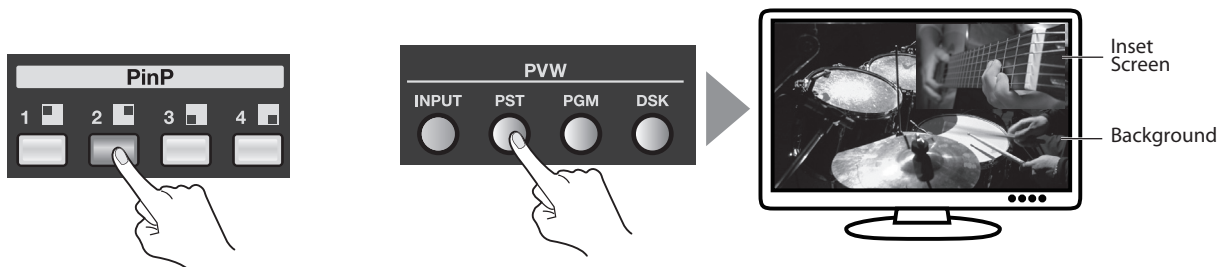

4. Adjust the size and position.

At the SCALING section, press the [CONTROL] button to make the [PinP] indicator light up. Use the [POSITION] joystick and the [SIZE] dial to adjust the display position and size of the inset screen.

* Refer to "Enlarging/Reducing the Picture" (p. 39).

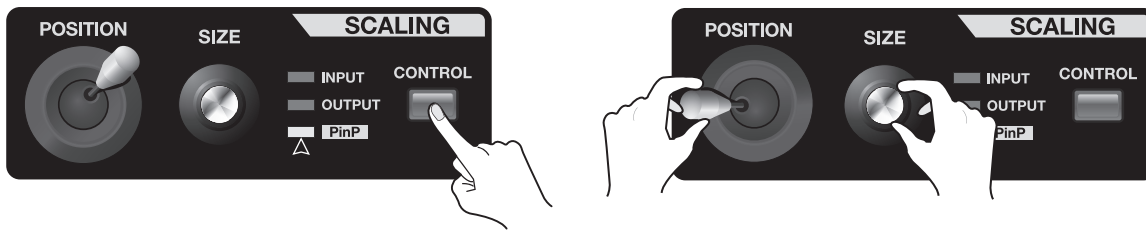

5. Output the composited results.

Pressing the [AUTO] button outputs the results of compositing. At this stage, the color of the pressed PinP selector button turns to red.

* Press the [AUTO] button again to make the inset screen disappear.



TIP

You can also make the inset screen appear or disappear by moving the video fader.

MEMO

When you carry out PinP composition, the current output channel becomes the background when one the PinP selector button is pressed. Select a channel for the inset screen on the opponent bus and operate the video fader or [AUTO] button to make the inset screen appear/disappear.

Compositing Using DSK

You can perform video transitions or picture-in-picture composition at upstream, then composite logos and text on the results at downstream. This feature makes it possible to switch the video or perform picture-in-picture while keeping logos/text displayed.

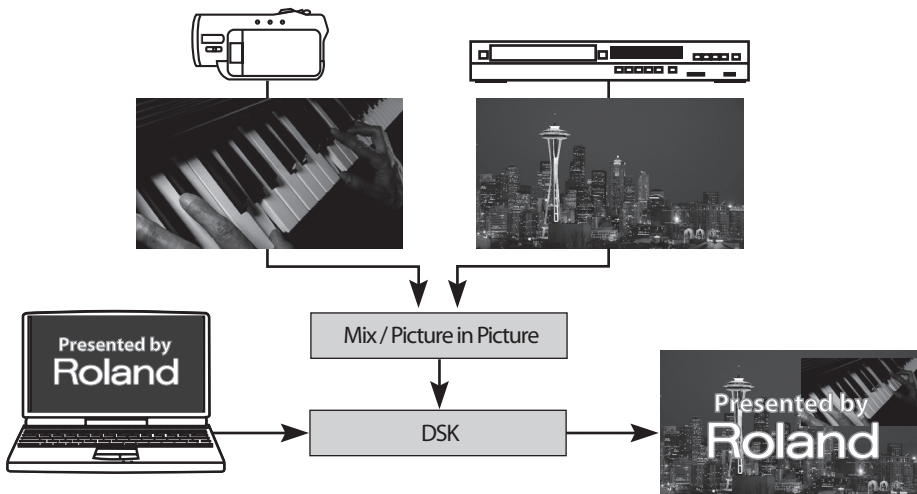

By default, the video on channel 4 is displayed in the foreground of DSK compositing. If you are using the unit with the default setting, input the logos and text to channel 4. To change the setting, refer to "Menu Operations and Menu List" (p. 45). Also, the extraction color for DSK compositing is set to black by default. You can use the menus to change this as well.

Use the button and the dial in the DSK Section to perform DSK compositing.

1. Select the background channel.

Select a channel for background using buttons on [A-BUS/PGM] input selectors.

2. Set the preview monitor to DSK mode.

Select the [DSK] in PVW selector to preview the DSK composition.

3. Adjust the amount of keying.

At the DSK section, turn the [KEY LEVEL] dial to adjust the amount of keying. Check the amount on the preview monitor.



4. Output the composited results.

At the DSK Section, press the [AUTO] button. The indicator of the button lights up and the results of compositing the logo or text are output.



5. Make the logo or text disappear.

Press the [AUTO] button in the DSK section again. The indicator goes dark and the logo or text disappears from the output.

When blue or green is selected as the DSK extraction color

When blue or green is selected as the DSK extraction color, the items below are added for setting. These do not appear on menu while black or white is selected as the extraction color.

- Y Level This adjust the brightness level of the extraction color.
- Pb Level This adjust the Pb level of the extraction color.
- Pr Level This adjust the Pr level of the extraction color.
- Gain This adjust the amount of edge blur of keying.

DSK	
PGM Output	OFF
Transition	Cut
Type	Chroma 1 (Blue)
Y Level	200
Pb Level	130
Pr Level	125
Gain	4
Source Channel	4

NOTE

While blue or green is selected, fade in/fade out of the foreground image is disabled. It appears/disappears with CUT when [AUTO] button is pressed.

Notes while composition using the DSK

A short black image is inserted the output if you carry out the operations below while you are compositing logo/text using the DSK.

- Switching of source channel for background or inset screen while you are using PinP and DSK.
- Switching of source channel while the transition effect is going on under the logo/text composited using the DSK.

Audio-related Features

Selecting an Audio Source

You can select the source for the audio to output via HDMI connectors in OUTPUT 1/2. At the Audio menu (p. 49), select one from below in [HDMI Output].

Ch.1 HDMI Audio	Only HDMI audio channel 1 is output.
Ch.2 HDMI Audio	Only HDMI audio channel 2 is output.
Ch.3 HDMI Audio	Only HDMI audio channel 3 is output.
Ch.4 HDMI Audio	Only HDMI audio channel 4 is output.
Audio In	This is the default setting. Input made via the [AUDIO IN] connectors on the rear panel is output.
Mixer	The mixed result of all above sources is output.

MEMO

Select [Mixer] in the Audio menu to adjust volume for the respective sources.

Adjusting the Audio Output Level

When you are outputting audio together with video from the HDMI connectors, you can use the steps below to adjust the output level.

1. Display the Audio menu.

Press the [MENU] button to display the menu. Use the [CURSOR] buttons to select [Audio], then press the [ENTER] button to display the Audio menu.

2. Select Main Volume.

Use the [CURSOR] buttons to select [Main Volume].

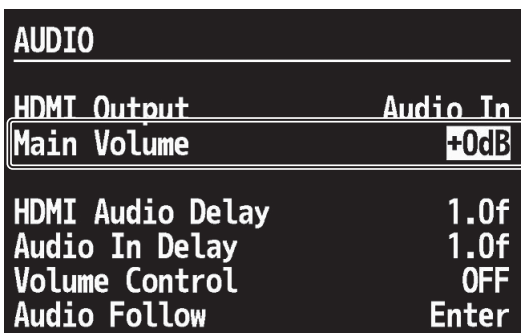

3. Adjust the output level.

Turn the [VALUE] dial to adjust the output level. Use the speakers or level meters on the peripheral equipment to adjust output level.

* The AUDIO indicator on the top panel indicates the output level.

4. Exit the menu.

Press the [EXIT] button several times to quit the menu.

MEMO

Turn on the [Volume Control] to enable the [Main Volume] control using the [VALUE] dial. However, it is not possible to control while menu is displayed. Exit the menu to control using the [VALUE] dial.

Aligning the Timing of Video and Audio (Lip-sync)

You can use the steps below to apply delay to audio output to align it with the timing of the video.

1. Display the Audio menu.

Press the [MENU] button to display the menu. Use the [CURSOR] buttons to select [Audio], then press the [ENTER] button to display the Audio menu.

2. Select the delay parameter.

Use the [CURSOR] buttons to select one of the following two items for adjusting the amount of delay.

HDMI Audio Delay	This adjusts the amount of delay for audio input via HDMI.
Audio In Delay	This adjusts the amount of delay for analog audio input via the AUDIO IN connectors.

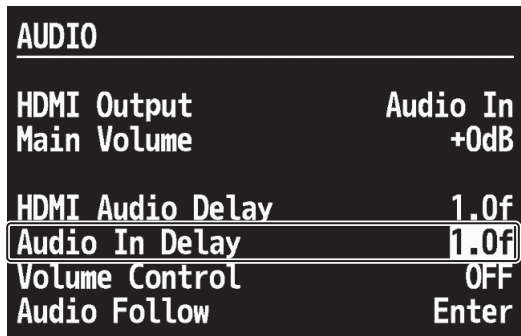
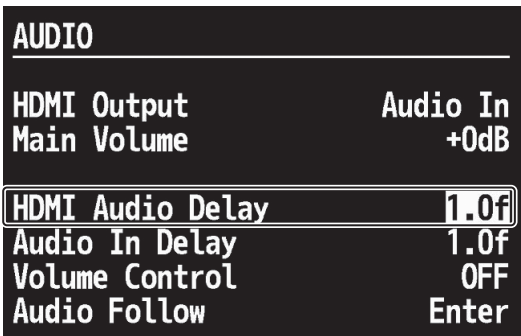

* By default, the delay amount is set to 1.0 frame. This matches to input > output latency of video.

3. Adjust the timing.

Turn the [VALUE] dial to adjust the amount of delay.

4. Exit the menu.

Press the [EXIT] button several times to quit the menu.

Linking Audio to Video (Audio Follow)

“Audio Follow” causes the audio associated with a video source to become prominent when that video source is selected. Only the (embedded) audio input on the same channel as the selected video channel is output — other channels are automatically muted.

1. Display the Audio menu.

Press the [MENU] button to display the menu. Use the [CURSOR] buttons to select [Audio], then press the [ENTER] button to display the Audio menu.

2. Display the Audio Follow menu.

Use the [CURSOR] buttons to select [Audio Follow]. Press the [ENTER] button to display the Audio Follow menu.

3. Select the channel.

Use the [CURSOR] buttons to select the channel, and tweak the [VALUE] dial to turn on the Audio Follow.

4. Exit the menu.

Press the [EXIT] button several times to quit the menu.



You can assign audio signals on the AUDIO INPUT connectors for one of the video channels as an associated audio source. Select [Audio In Audio Follow] in step 3. Turn the [VALUE] dial to select the video channel for which the Audio Input is assigned.



When the Audio Follow is on, [HDMI Output] is automatically set for [Mixer].

About Other Features

Enlarging/Reducing the Picture

Using the [SIZE] dial in the SCALING section, you can enlarge or reduce the view of the picture. You can also use the [POSITION] joystick to change the display position.

* You can enlarge or reduce the picture within a range of 10% to 1,000%.

Enlarging/Reducing the Source Picture

1. Put the channel of the video you want to enlarge or reduce into standby.

Select the channel of the video you want to enlarge or reduce and put it into standby.

2. Preview the video on the selected channel.

Select the [PST] in PVW selector to display the video on the channel you selected in step 1 on the preview monitor.

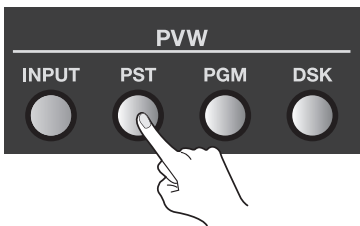

3. Select what to enlarge or reduce.

In the SCALING section, press the [CONTROL] button to make the [INPUT] indicator light up.

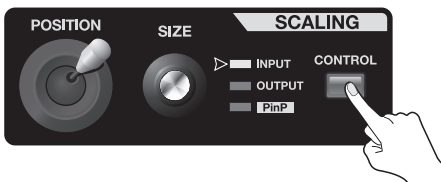

4. Perform enlargement or reduction and adjust the display position.

Use the [SIZE] dial to enlarge or reduce the view. Use the [POSITION] joystick to adjust its display position.

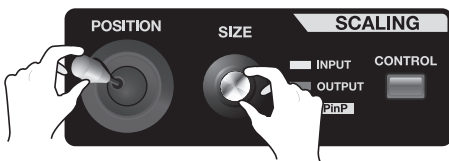

MEMO

You can also enlarge or reduce the picture and adjust its display position by changing the values of [Zoom] and [Position] at the Input menu. At the Input menu, you can also change cropping and the aspect ratio for the picture.

5. Output the enlarged or reduced picture.

Press the [AUTO] button or move the video fader to output the channel of the previewed video.

Enlarging/Reducing the Currently Output Picture

To enlarge or reduce the video currently being output, go to the SCALING section and use the [CONTROL] button to make the [OUTPUT] indicator light up. You can use the same operation to enlarge or reduce the final video output and adjust its display position.

MEMO

You can also enlarge or reduce the picture and adjust its display position by changing the values of [Zoom] and [Position] at the Output menu. At the Output menu, you can also enlarge or reduce the vertical and horizontal dimensions of the picture independently.

Saving/Recalling Settings

Saving the Current Settings to Internal Memory

You can use the [MEMORY] buttons to save the current settings to the internal memory. The internal memory banks are numbered from 1 to 5, and you can save up to five sets of settings in each bank, for a maximum of 25.

NOTE

When [Memory Protect] on the System menu is set to [ON], saving operations are not possible. Turn it to [OFF] when you save.

1. Put the unit in the state you want to save.

Operate the dials and buttons on the panel to put the V-40HD in the state you want to save.

2. Put the unit into standby for saving.

Press the [STORE] button to put the unit into standby for saving. The number of the last-selected button flashes at this time.



3. Select the bank to save to.

Press the [BANK] button. The button for the currently selected bank lights up. Choose a bank from [1] to [5] to select the destination for saving.



4. Select the number to save to.

Choose a memory number from [1] to [5] to select the destination for saving. Settings are saved at the selected memory number in the selected bank.

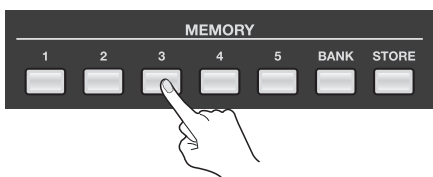

Recalling Saved Settings

When the V-40HD starts up, the settings saved at memory number 1 in bank 1 are loaded. To recall saved settings, first press a [BANK] button to select the bank. Pressing the button for a memory number then puts the panel in the saved state.

TIP

- When [Auto Memory] in the system menu is [ON], the setting value is automatically stored at memory 1-1 when you press [MENU] or [CURSOR] buttons after making a change in setting a value. Auto saving does not work when cross-point buttons or video fader is operated.
- When [Recall Lock] is [ON], memory [1]–[5] buttons are disabled and you cannot recall settings.
- Going to the System menu and setting [Memory Switch Fade] to [ON] automatically applies an output fade when saved settings are called up. When recall finishes and the settings have changed, the output fade ends.

NOTE

Settings of some items cannot be saved to the MEMORY buttons (1-1 through 5-5). These are saved to the internal memory as part of unit's common setting. Refer to "System menu" (p. 49) for such items.

Using a USB Memory Device

Connecting and Formatting a USB Memory Device

NOTE

When using a USB memory device, give attention to the following points.

- Carefully insert the USB memory all the way in-until it is firmly in place. Also, be careful to orient the USB memory device correctly front and back and in the correct direction for insertion, and insert it firmly, as far as it will go. Never insert using undue force.
- Operation has been tested for commonly available USB memory devices, but operation of all USB memory devices is not assured. Depending on the manufacturer and type of the USB memory device, correct operation may not be possible.

1. Connect the USB memory device.

Connect the USB memory device to the USB MEMORY connector on the rear panel.

2. Display the System menu.

Press the [MENU] button to display the menu. Use the [CURSOR] buttons to select [System], then press the [ENTER] button to display the System menu.

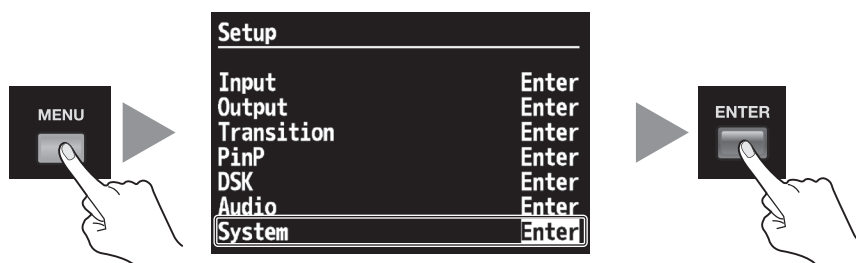

3. Select the Format menu.

Use the [CURSOR] buttons to go to [USB Memory] and select [Format], then press the [ENTER] button.



4. Format the USB memory device.

Pressing the [ENTER] button in step 3 makes the message [Push ENTER to execute] appear. To execute formatting, press the [ENTER] button.

- * Formatting permanently deletes all data saved on the USB memory device.
- * [Processing.] message appears while formatting. Do not turn the power off while formatting.

5. Exit the menu.

Press the [EXIT] button several times to quit the menu.

NOTE

Note that USB memory devices not formatted on the V-40HD cannot be recognized.

Copying Settings to a USB Memory Device

You can copy data saved in the internal memory to a formatted USB memory device. A batch copy of all data in internal memory from 1-1 to 5-5 and the unit's common setting is carried out at this time.

1. Display the System menu.

Press the [MENU] button to display the menu. Use the [CURSOR] buttons to select [System], then press the [ENTER] button to display the System menu.

2. Select the Save menu.

Use the [CURSOR] buttons to go to [USB Memory] and select [Parameter], then press the [ENTER] button. The display changes to a screen for selecting the operation.

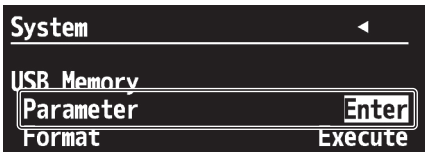

3. Select the Save As menu.

Use the [CURSOR] buttons to select [Save As], then press the [ENTER] button. The display changes to a screen for editing the file name.

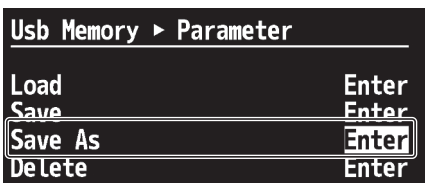

4. Edit the file name.

Use the [CURSOR] buttons to move the cursor left or right, and turn the [VALUE] dial to change the text.

* The extension of the file name is [V04]. If you have edited the file name on your computer, lower-case letters are displayed after conversion to upper case.



5. Save to the USB memory device.

Pressing the [ENTER] button displays the message [Push ENTER to execute]. To save, press the [ENTER] button.

* [Processing.] message appears while saving. Do not turn the power off while saving.

6. Exit the menu.

Press the [EXIT] button several times to quit the menu.

Changing the Preview Labels

You can change the text for channel names displayed on the preview monitor. Up to 8 characters of text can be displayed.

1. Display the System menu.

Press the [MENU] button to display the menu. Use the [CURSOR] buttons to select [System], then press the [ENTER] button to display the System menu.

2. Select the label whose text you want to change.

Use the [CURSOR] buttons to select [PVW Label], then press the [ENTER] button to display the list. Use the [CURSOR] buttons to select the label whose text you want to change. Pressing the [ENTER] button switches the display to the screen for changing the text.

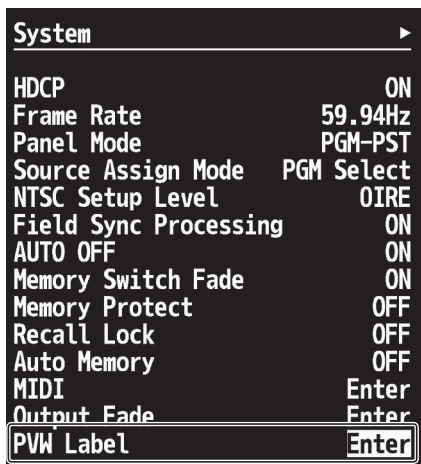

MEMO

You can also hide the labels by going to the [PVW Label] list and setting [Indicate] to [OFF].

3. Change the text string.

Use the [CURSOR] buttons to move the cursor left or right, and turn the [VALUE] dial to change the text.



4. Exit the menu.

Press the [ENTER] button to finalize the text. Then, press the [EXIT] button several times to quit the menu.

NOTE

The display on the preview monitor is not updated while editing is in progress. The display is updated when you quit the menu.

Returning to the Factory-default State

This returns various settings to their factory defaults. If following the instructions for a procedure results in operation that differs from what is described in the Owner's Manual, execute a factory reset.

* Executing a factory reset causes all setting values saved up to then to be lost. Be aware that all settings saved to MEMORY buttons are also lost.

1. Display the System menu.

Press the [MENU] button to display the menu. Use the [CURSOR] buttons to select [System], then press the [ENTER] button to display the System menu.

2. Select the Factory Reset menu.

Use the [CURSOR] buttons to select [Factory Reset], then press the [ENTER] button. The message [Push ENTER to execute] appears.

* If the target menu is not displayed, press the left or right [CURSOR] button to change the page.

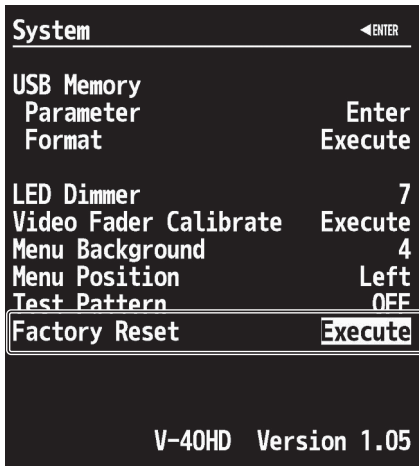

3. Execute the factory reset.

Pressing the [ENTER] button executes the factory reset.

* [Processing.] message appears while executing factory reset. Do not turn the power off while executing.

4. Exit the menu.

Press the [EXIT] button several times to quit the menu.



Hold down the WIPE PATTERN [1], [MIX] and PinP [3] buttons and turn on the power. "Fr" is displayed on the TRANSITION indicator and the unit starts in its factory-default state.

Menu Operations and Menu List

Menu Operations

To make various settings for the V-40HD, use the menu screens displayed on the preview monitor. Menu operations are described below.

* For information on the menu items, refer to the following pages.

1. Display the menu screen.

Go to the SETUP section and press the [MENU] button to display the menu screen. Displayed initially is the first level.

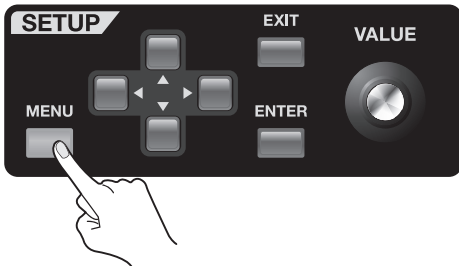

Input	Set input parameters like source assignments.
Output	Set output parameters like output formats.
Transition	Set parameters of transition effects.
PinP	Set parameters of Picture in Picture.
DSK	Set parameters of Down Stream Keying composition.
Audio	Set parameters of Audio.
System	Set system configuration of the V-40HD.

2. Select the target menu.

Use the up and down [CURSOR] buttons to select the target menu item at the first level.

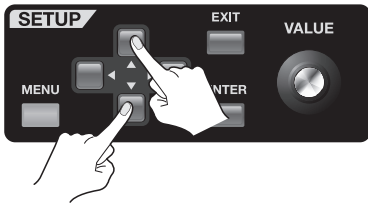

3. Select the target item.

Use the up and down [CURSOR] buttons to select the target item.

* If the items span two or more pages, a triangle symbol is displayed at the top of the screen. When this symbol is displayed, you can change the page shown pressing the left or right [CURSOR] buttons.



4. Proceed to the setup screen.

When [ENTER] is displayed at the top of the screen, you can proceed to a detailed setup screen for the item by pressing the [ENTER] button.



5. Change the setting value.

If the displayed setting value is highlighted, you can change the value by turning the [VALUE] dial.



* You can change a setting value up or down by 10 units at a time by holding down the [ENTER] button and turning the [VALUE] dial.

* You can also return a setting value to its factory default by holding down the [ENTER] button and pressing the [EXIT] button.

* Hold down [ENTER] button and [EXIT] button for 3 seconds or longer to return the setting values of all the displayed items to factory default values. This returns the values of displayed items only. The values of the not-displayed items do not return.

6. Exit the menu.

You can go back one level by pressing the [EXIT] button. When you are finished making the settings, press the [EXIT] button several times to quit the menu.

NOTE

The setting value is not stored in internal memory unless it is saved to a [MEMORY] button. Refer to "Saving/Recalling Settings" (p. 40) and save the settings before turning off the power.

Menu List

MEMO

Display and setting values shown enclosed in square brackets (“[]”) are factory-default values. You can return a setting value to its factory default by holding down the [ENTER] button and pressing the [EXIT] button.

Input menu

Ch.1 - Ch.4	No Signal, 720x480@59.94 Hz - 1920x1200@60.00 Hz	This part displays the format of the current input signal.
	[HDMI], RGB/Component, Composite, Shared Input	This part displays the currently selected input connector. Press [ENTER] to go to detailed setup of each channel.
Background	R16: G16: B16	Press [ENTER] to go to detailed setup of Background.

Detailed setup of Ch.1 - Ch.4

* Setting of Color Space and Flicker Filter is not possible while you are selecting Composite as the source.

Color Space	[Auto], RGB(0-255), RGB(16-235), YCC(SD), YCC(HD)	<p>This selects the color space setting as defined below.</p> <ul style="list-style-type: none"> • Auto The setting is automatically detected according to the input signal. • RGB (0-255) This enables the full range of black to white for an RGB signal. • RGB (16-235) This eliminates the low blacks and high whites from the input signal. • YCC (SD) YCbCr signal where the chroma component (CbCr) is subsampled. • YCC (HD) Pure YCbCr signal with no chroma subsampling.
Flicker Filter	[OFF], ON	This turns the flicker filter on/off. The flicker filter works to blur or equalize the brightness differences between scanning lines.

Scaling	Zoom	10% - [100%] - 1000%	This sets the zoom ratio.
	Type	[Full], Letterbox, Crop, Dot by Dot, Manual	<p>This selects the scaling type.</p> <ul style="list-style-type: none"> • Full The input image is displayed fully on the output screen. The aspect ratio is changed to fit the screen.. • Letterbox The entirety of the input image is displayed on the output screen horizontally while maintaining the aspect ratio. If necessary, this means black bars will be across the top and bottom. • Crop The input image is displayed fully on the output screen horizontally while maintaining the aspect ratio. If necessary, this means black bars will be across the top and bottom.. • Dot by Dot No scaling is engaged. • Manual The scaling is controlled based on size and position settings as described below.

When [Manual] is selected, you can make the following settings:

Manual Size H	-2000 - [0] - +2000	This sets the horizontal size of the incoming source.
Manual Size V	-2000 - [0] - +2000	This sets the vertical size of the incoming source.
Position H	-1920 - [0] - +1920	This sets the horizontal position of the incoming source.
Position V	-1920 - [0] - +1920	This sets the vertical position of the incoming source.

* The setting-value range varies depending on the input/output format settings. The values shown above are minimum/maximum values.

Color Correction	Brightness	-64 - [0] - +63	This adjusts the brightness.
	Contrast	-64 - [0] - +63	This adjusts the contrast.
	Saturation	-64 - [0] - +63	This adjusts the saturation.
	Red	-64 - [0] - +63	This adjusts the red level.
	Green	-64 - [0] - +63	This adjusts the green level.
	Blue	-64 - [0] - +63	This adjusts the blue level.

* You can adjust the values of below items only while you are selecting RGB/Component as the source.

Sampling	Use the following items to make settings related to sampling.	
Auto Sampling	Execute	Press [ENTER] to execute the auto sampling.
Position H	-1920 - [0] - +1920	This sets the horizontal position.
Position V	-1200 - [0] - +1200	This sets the vertical position.
Frequency	-128 - [0] - +127	This sets the frequency.
Phase	-128 - [0] - +127	This sets the phase.

Detailed setup for Background

Color Setting	Use the following items to make settings related to background color.	
Red	-64 - [0] +63	This adjusts the red level.
Green	-64 - [0] +63	This adjusts the green level.
Blue	-64 - [0] +63	This adjusts the blue level.

Output menu

Output 1/2 Format		
HDMI/RGB Component	480i4:3/576i4:3, 480i16:9/576i16:9, 480p4:3/576p4:3, 480p16:9/576p16:9, 720P, 1080i, [1080P], VGA, SVGA, XGA, WXGA, FWXGA, SXGA, SXGA+, UXGA, WUXGA	This selects the format of OUTPUT 1/2 (HDMI and RGB/Component).
Composite	[480i4:3/576i4:3], 480i16:9/576i16:9	This selects the Composite output format.
PVW Out Format	1080p	This displays the PVW OUT format (fixed).
Output 1	Press [ENTER] to go to detailed setup of Output 1.	
Output 2	Press [ENTER] to go to detailed setup of Output 2.	
Composite	Press [ENTER] to go to detailed setup of Composite.	
PVW Output	Press [ENTER] to go to detailed setup of PVW Out.	

Detailed setup for Output 1/2

Color Space	RGB(0-255), RGB(16-235), YCC(422), YCC(444)	This selects the color space. When selecting [Auto], the color space is automatically selected depending on the output format. For details of the values, see [Color Space] in the Input menu (p. 46) * When 480i or 576i is selected as the output format, you cannot select the RGB values.
Bus Assign	[PGM], PST, DSK Source	This selects the bus for output.
DVI-D/HDMI Signal	DVI-D, [HDMI]	This selects the output mode of the HDMI connectors.
Tearing Filter	[OFF], ON	This turns on/off the tearing filter. The output delays for 1 frame when this is tuned on.

Scaling	Zoom	50% - [100%] - 200%	This sets the zoom ratio.
	Type	[Full], Manual	This selects the cropping format. For details of the values, see [Type] of [Scaling] in the Input menu (p. 46)
	Size H	-1920 - [0] - +1920	This sets the horizontal size.
	Size V	-1200 - [0] - +1200	This sets the vertical size.
	Position H	-175 - [0] - +175	This sets the horizontal position.
	Position V	-1200 - [0] - +1200	This sets the vertical position.
Color Correction	Brightness	-64 - [0] - +63	This adjusts the brightness.
	Contrast	-64 - [0] - +63	This adjusts the contrast.
	Saturation	-64 - [0] - +63	This adjusts the saturation.
	Red	-64 - [0] - +63	This adjusts the red level.
	Green	-64 - [0] - +63	This adjusts the green level.
	Blue	-64 - [0] - +63	This adjusts the blue level.

Menu Operations and Menu List

Detailed setup for Composite

Scaling	Zoom	50% - [100%]	This sets the zoom ratio.
	Type	[Full], Letterbox, Crop, Manual	This selects the cropping format. For details of the values, see [Type] of [Scaling] in the Input menu (p. 46)
	Size H	-1000 - [0] - +1000	This sets the horizontal size.
	Size V	-540 - [0] - +540	This sets the vertical size.
	Position H	-200 - [0] - +200	This sets the horizontal position.
	Position V	-150 - [0] - +150	This sets the vertical position.
Color Correction	Brightness	-64 - [0] - +63	This adjusts the brightness.
	Contrast	-64 - [0] - +63	This adjusts the contrast.
	Saturation	-64 - [0] - +63	This adjusts the saturation.
	Red	-64 - [0] - +63	This adjusts the red level.
	Green	-64 - [0] - +63	This adjusts the green level.
	Blue	-64 - [0] - +63	This adjusts the blue level.

Detailed setup for PVW Out

DVI-D/HDMI Signal	DVI-D, [HDMI]	This selects the output mode of the PVW OUT.
-------------------	---------------	--

Transition menu

Time	0.0s - [1.0s] - 10.0s, 0s00f - 10s00f, 0f - 300f	This sets the transition time based on the units selected.
Unit	[Seconds], Seconds + Frames, Frames	This selects the unit for transition time.
Wipe Pattern	1, 2, MIX, CUT	This selects the wipe pattern from wipe pattern memory 1 or 2 and MIX (cross-fade) or CUT.

Detailed setup for Wipe Pattern 1/2

Pattern	Horizontal, Vertical, Horizontal Open, Vertical Open, Upper Left, Upper Right, Lower Left, Lower Right, Box	This selects the type of wipe pattern.
Direction	[Normal], Reverse, N/R	This selects the wipe direction. Selecting [N/R] switches the wipe direction (normal <> reverse) reciprocally.

PinP menu

Status	[OFF], PVW, PGM	Selects the output status of PinP compositing from among the following: OFF : No display. PVW : Displayed at preview output. PGM : Displayed at final output.
--------	-----------------	--

Detailed setup for Position 1 - 4

Make settings related to the PinP [1] - [4] buttons.

Size	10% - [30%] - +100%	This sets the size of the inset screen.
Position H	-100% - +100%	This sets the horizontal position of the inset screen.
Position V	-100% - +100%	This sets the vertical position of the inset screen.
Cropping Type	[Original], 4:3, 5:4, 16:9, Manual	This selects the image ratio when cropping the inset screen.

When Manual is selected for Cropping Type, you can make the following settings:

Manual Cropping H	-2000 - [0] - +2000	This sets the horizontal cropping width.
Manual Cropping V	-2000 - [0] - +2000	This sets the vertical cropping width.
View	These specify zoom in/out amount and position of the image displayed in the inset screen.	
Size	[100%] - 1000%	This sets the amount of zoom in or out.
Position H	-1920 - [0] - +1920	This sets the horizontal display position.
Position V	-1200 - [0] - +1200	This sets the vertical display position.

DSK menu

PGM Output	[OFF],ON	This turns final output of DSK on/off.
Transition	CUT, [MIX]	This selects the way of appearance/disappearance of foreground image.
Type	Luminance 1 (White), [Luminance 2 (Black)], Chroma 1 (Blue), Chroma 2 (Green)	This select the type (extraction color) of DSK.
Level	0 - 15	This sets transparency level when Luminance 1 or 2 is selected.
Y Level	0 - 255	This sets brightness level of the extraction color when Chroma 1 or 2 is selected.
Pb Level	0 - 255	This sets Pb level of the extraction color when Chroma 1 or 2 is selected.
Pr Level	0 - 255	This sets Pr level of the extraction color when Chroma 1 or 2 is selected.
Gain	0 - 9	This sets amount of edge blur when Chroma 1 or 2 is selected.
Source Channel	1 - [4]	This selects the channel of the picture to overlay for DSK composition.

Audio menu

HDMI Output	Ch.1 HDMI Audio, Ch.2 HDMI Audio, Ch.3 HDMI Audio, Ch.4 HDMI Audio, [Audio In], Mixer	This selects the audio source to output.
Main Volume	Mute, -48dB - [0dB] - +6dB	This adjusts the volume of audio output.
Mixer	Pressing [ENTER] changes to a detailed setup screen for Mixer.	
HDMI Audio Delay	0.0 - [1.0] - 12.0 (in 0.1-frame steps)	This sets the amount of delay for the HDMI audio input.
Audio In Delay	0.0 - [1.0] - 12.0 (in 0.1-frame steps)	This sets the amount of delay for the analog audio input.
Volume Control	[OFF], ON	When this is set to ON, you can use the [VALUE] dial to adjust the volume (only when no menu is displayed).
Audio Follow	Pressing [ENTER] changes to a detailed setup screen for the Audio Follow function.	

Detailed setup for Mixer

Ch.1 HDMI Audio Volume	Mute, -48dB - [0dB] - +6dB	This adjusts the volume of HDMI channel 1.
Ch.2 HDMI Audio Volume	Mute, -48dB - [0dB] - +6dB	This adjusts the volume of HDMI channel 2.
Ch.3 HDMI Audio Volume	Mute, -48dB - [0dB] - +6dB	This adjusts the volume of HDMI channel 3.
Ch.4 HDMI Audio Volume	Mute, -48dB - [0dB] - +6dB	This adjusts the volume of HDMI channel 4.
Audio In Volume	Mute, -48dB - [0dB] - +6dB	This adjusts the volume of the analog audio input.

Detailed setup for Audio Follow

Ch.1 HDMI Audio Follow	[OFF], ON	This switches Audio Follow on/off for HDMI channel 1.
Ch.2 HDMI Audio Follow	[OFF], ON	This switches Audio Follow on/off for HDMI channel 2.
Ch.3 HDMI Audio Follow	[OFF], ON	This switches Audio Follow on/off for HDMI channel 3.
Ch.4 HDMI Audio Follow	[OFF], ON	This switches Audio Follow on/off for HDMI channel 4.
Audio In Audio Follow	[OFF], Ch.1, Ch.2, Ch.3, Ch.4, BG	This selects the video channel that the analog Audio Input is assigned to follow.

System menu

NOTE

The settings for items shown in gray in the table are not saved to MEMORY buttons (1-1 through 5-5). You cannot save multiple settings for these items using the MEMORY buttons. Only one setting per item can be saved to the V-40HD's internal memory. Such settings are saved when you exit the menu. So don't turn off the power while the menu is displayed.

HDCP	[OFF], ON	This turns the HDCP mode on/off. A confirmation screen appears when [ON] is selected.
Frame Rate	[59.94Hz], 50Hz	This selects the system frame rate.
Panel Mode	A/B, [PGM-PST]	This selects the operation mode. For PGM-PST and A/B, see p. 28 and p. 31.
Source Assign Mode	OFF, [PGM Select], PST Select	This changes the operation mode of the input assign buttons (p. 19).
NTSC Setup Level	[0IRE], 7.5IRE	This selects the NTSC IRE level. * An IRE is a unit used in the measurement of composite video signals and in particular this controls black level setup. Typically 7.5 is used in US broadcasts while 0 is used in Japan.
Field Sync Processing	OFF, [ON]	Turn this ON to synchronize the fields of interlace input and the OUTPUT 1.
AUTO OFF	OFF, [ON]	When AUTO OFF is set to ON, the power is turned off after 240 minutes.
Memory Switch Fade	OFF, [ON]	When ON, this will automatically engage an output fade between memory selections.
Memory Protect	[OFF], ON	When ON, this disables the ability to save to MEMORY buttons.
Recall Lock	[OFF], ON	When ON, this disables recalling operation with the memory buttons.
Auto Memory	[OFF], ON	When ON, the current setting of the V-40HD is stored automatically at memory position 1-1.
MIDI	Pressing [ENTER] changes to a detailed setup screen for MIDI.	
Output Fade	Pressing [ENTER] changes to a detailed setup screen for output fade.	
PVW Label	Pressing [ENTER] changes to an editing screen for PVW labels.	
USB Memory	This makes settings related to USB memory devices.	
	Parameter	Pressing [ENTER] lets you set parameters related to saving to/loading from a USB memory device.
	Format	Pressing [ENTER] changes to a formatting screen for the USB memory device.
LED Dimmer	0 - [7]	This adjusts the brightness level of the top panel LEDs.
Video Fader Calibrate	Pressing [ENTER] changes to a calibration screen for the video fader.	
Menu Background	0 - [4] - 7	This sets the transparency of the menu background.
Menu Position	[Left], Right	This changes the position of the menu display. You can also change this by holding down the [MENU] button and pressing the left or right [CURSOR] button.
Test Pattern	[OFF], Color Bar 75%, Color Bar 100%, Ramp, Step, Hatch	This turn off or turns on a selected test pattern.
Factory Reset	This returns the V-40HD to its factory-default settings. Pressing [ENTER] displays a confirmation screen.	

Detailed setup for MIDI

Status	OFF, [Native], V-LINK Master, V-LINK Slave, MVC Slave	This selects the MIDI remote-control mode of the V-40HD.
Through Output	[OFF], ON	This selects the operation of the MIDI OUT/THRU connector.
Channel	[1] - 16	This selects the MIDI channel to use when Native is selected.

Detailed setup for output fade

Time	0.0s - [0.5s] - 10.0s	This sets the duration of the fade.
Audio Follow	OFF, [ON]	This selects whether audio volume is interlinked with output fade.
Color Setting	Use the following items to make settings related to the output fade color.	
Red	0 - [16] - 255	This sets the red level.
Green	0 - [16] - 255	This sets the green level.
Blue	0 - [16] - 255	This sets the blue level.

Editing PVW labels

Indicate	OFF, [ON]	This turns display of red/green borders and labels on/off.
PST	[""PST""]	Pressing [ENTER] displays the label entry screen during PST display.
PGM	[""PGM""]	Pressing [ENTER] displays the label entry screen during PGM display.
DSK	[""DSK""]	Pressing [ENTER] displays the label entry screen during DSK display.
Ch. 1		
HDMI	[""CH.1 HDMI""]	Pressing [ENTER] displays the label entry screen for channel 1 HDMI.
RGB/Component	[""CH.1 RGB""]	Pressing [ENTER] displays the label entry screen for channel 1 RGB/Component.
Composite	[""CH.1 CMP""]	Pressing [ENTER] displays the label entry screen for channel 1 Composite.
Ch. 2		
HDMI	[""CH.2 HDMI""]	Pressing [ENTER] displays the label entry screen for channel 2 HDMI.
RGB/Component	[""CH.2 RGB""]	Pressing [ENTER] displays the label entry screen for channel 2 RGB/Component.
Composite	[""CH.2 CMP""]	Pressing [ENTER] displays the label entry screen for channel 2 Composite.
Shared Input	[""CH.2 SHR""]	Pressing [ENTER] displays the label entry screen for channel 2 Shared Input.
Ch. 3		
HDMI	[""CH.3 HDMI""]	Pressing [ENTER] displays the label entry screen for channel 3 HDMI.
RGB/Component	[""CH.3 RGB""]	Pressing [ENTER] displays the label entry screen for channel 3 RGB/Component.
Composite	[""CH.3 CMP""]	Pressing [ENTER] displays the label entry screen for channel 3 Composite.
Shared Input	[""CH.3 SHR""]	Pressing [ENTER] displays the label entry screen for channel 3 Shared Input.
Ch. 4		
HDMI	[""CH.4 HDMI""]	Pressing [ENTER] displays the label entry screen for channel 4 HDMI.
RGB/Component	[""CH.4 RGB""]	Pressing [ENTER] displays the label entry screen for channel 4 RGB/Component.
Composite	[""CH.4 CMP""]	Pressing [ENTER] displays the label entry screen for channel 4 Composite.
Shared Input	[""CH.4 SHR""]	Pressing [ENTER] displays the label entry screen for channel 4 Shared Input.

Parameter setting for USB memory devices

Load	Pressing [ENTER] displays the screen to select a file to load.
Save	Pressing [ENTER] displays the screen to select a file to save.
Save As	Pressing [ENTER] displays the screen to edit the file name.
Delete	Pressing [ENTER] displays the screen to select a file to delete.

Formatting a USB memory device

Format	Push Enter to Execute.	Pressing [ENTER] starts formatting.
--------	------------------------	-------------------------------------

Video fader calibration

Set at upper position and push ENTER.	Pressing [ENTER] starts calibration of the upper position.
Set at lower position and push ENTER.	Pressing [ENTER] starts calibration of the lower position.

Factory Reset

Factory Reset	Push Enter to Execute.	Pressing [ENTER] executes factory reset..
---------------	------------------------	---

Appendices

Main Specifications

Signal Processing

Video	4 : 4 : 4 (Y/Pb/Pr), 10 bits * The output processing is 4:2:2, 8 bits.
Audio processing	Sampling rate : 24 bits/48 kHz, 2ch

Input/Output Formats

Refer to "About Input/Output Formats" (p. 24).

Input Jacks

Video	HDMI	Type A (19 pins) x 4 (INPUT 1-4)
	RGB/Component	HD DB-15 type x 4 (INPUT 1-4)
	Composite	BNC type x 4 (INPUT 1-4)
Audio	1/4-inch TRS phone type (balanced/unbalanced) x 1 pair (AUDIO INPUT)	

Output Jacks

Final output	HDMI	Type A (19 pins) x 2 (OUTPUT 1/2)
	RGB/Component	HD DB-15 type x 2 (OUTPUT 1/2)
	Composite	BNC type x 1 (OUTPUT 1)
Preview output	HDMI	Type A (19 pins) x 1

Other Jacks

Tally	HD DB-15 type x 1 (max input : 12 V/200 mA, Open collector type)
MIDI	5 pins DIN type x 2 (IN, OUT/THRU)
RS-232C	9 pins D-sub type x 1
USB	A type x 1 (host, for USB memories)

Signal Level and Impedance

RGB/Component	Signal level	0.7Vp-p (H, V : 5V TTL)
	Impedance	75 ohms
Composite	Signal level	1.0Vp-p (Luminance) 0.286Vp-p (NTSC chroma) 0.3Vp-p (PAL chroma)
	Impedance	75 ohms
Analog audio	Nominal input level	+4 dBu
	Maximum Input Level	+22 dBu
	Impedance	15 k ohms

Effects

Transition	Mix, Cut, Wipe (9 patterns)
Composition	Picture in Picture, DSK (Luminance Key / Chroma Key)
Audio	Delay (0.0-12.0 frames)
Others	Output Fade (video/audio)

Others

Power Supply	DC 12 V (AC Adaptor)
Current Draw	2.6 A
Dimensions	317 (W) x 266 (D) x 108 (H) mm, 12-1/2 (W) x 10-1/2 (D) x 4-1/4 (H) inches
Weight (excl. AC adaptor)	3.4 kg, 7 lbs 8 oz
Accessories	AC Adaptor (4 pins XLR type connector), Power Cord, RCA-BNC conversion plug x 4, Owner's manual

* 0 dBu = 0.775 Vrms

* In the interest of product improvement, the specifications and/or appearance of this unit are subject to change without prior notice.

About Remote Control

MIDI and RS-232C

The V-40HD supports remote control via MIDI and the RS-232C interface, enabling you to operate the unit remotely from an external device. When performing remote control, download "Remote Control Guide" from the following Roland website.
<http://www.roland.com/manuals/>

MIDI VISUAL CONTROL



The V-40HD can be operated remotely from a device that supports MIDI Visual Control. MIDI Visual Control is a feature that uses MIDI to link visual expression to a musical performance.

About the Security Slot

You can attach a commercially available security wire here to prevent theft.
<http://www.kensington.com/>



Dimensions

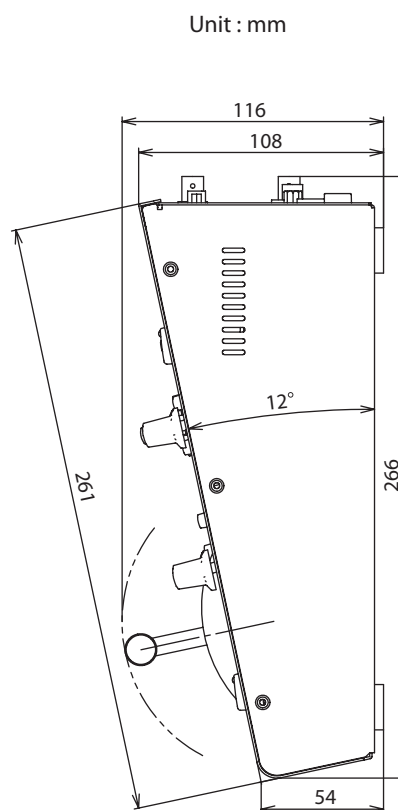
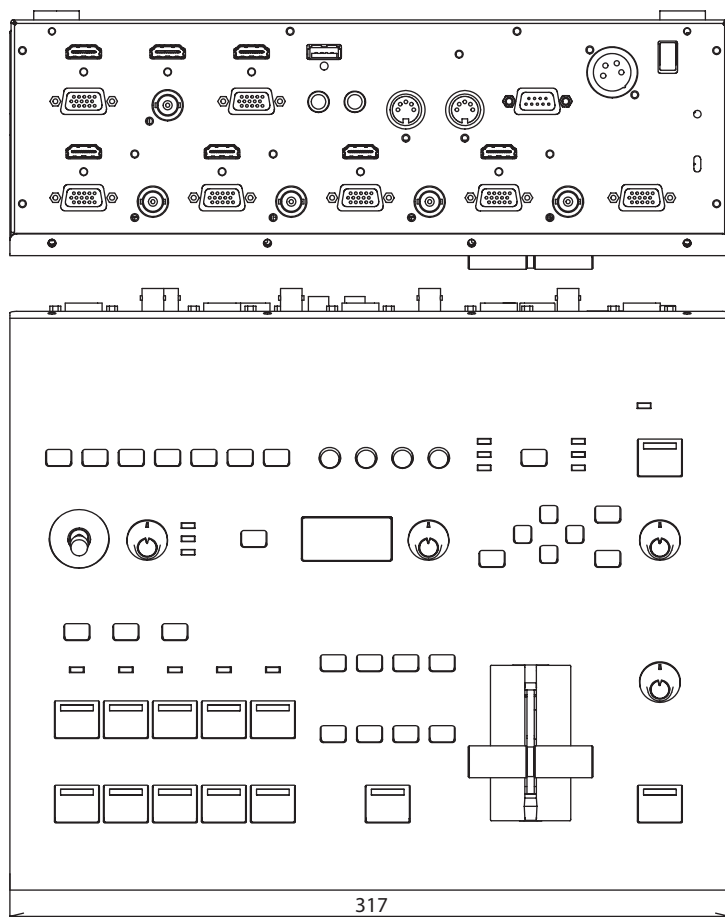

Unit : mm

Troubleshooting

V-40HD does not boot up

Are the HDMI connectors on the OUTPUT 1/2 and the PVW OUT connected properly?

When HDMI outputs from any HDMI devices are connected to the OUTPUT 1/2 or the PVW OUT by mistake, the V-40HD may not boot up.

Nothing is displayed on the preview monitor.

Does the connected monitor support a resolution and refresh rate of 1920 x 1080/60 Hz (progressive)?

Nothing is displayed if the monitor is not compatible. Also, nothing is displayed if the monitor does not support HDCP signals. If you are making the connection using an HDMI-DVI conversion cable, go to the Output menu and select DVI-D in PVW Output.

Composite input is not output.

Is composite assigned as the source?

In the factory-default state, HDMI input is assigned. The assignment must be changed to composite input (p. 20).

Does the unit's frame rate match with it of input signal?

If not, the signal does not come out.

Analog RGB input is not output.

Is RGB assigned as the source?

In the factory-default state, HDMI input is assigned. The assignment must be changed to analog RGB input (p. 19).

* The same operation is also necessary when using a conversion cable to make an analog-component connection.

Is the refresh rate 60 Hz or less?

If the refresh rate exceeds 60 Hz, the unit does not recognize the input signal.

HDMI input is not output.

Is HDMI assigned as the source?

If this is not assigned correctly, the signal cannot be detected.

Is the HDCP applied to the input signal?

If you are attempting to input the signal with HDCP, turn the HDCP setting on.

Output colors are not correct.

Has the setting for color space been made correctly?

- At the Input menu, set the channels correctly.
- At the Output menu, set the color space correctly.

Is the OUTPUT FORMAT setting is supported by the connected monitor ?

No output is made via the RGB/COMPONENT connectors of OUTPUT 1/2.

Has the setting for inputting HDCP signals been made?

When [HDCP] on the System menu is set to [ON], output via the RGB/COMPONENT connectors is stopped.

* Note, however, that HDMI output continues.

Is an interlace format selected as the output format?

If you are attempting to output from the RGB/COMPONENT connectors, select a progressive or RGB format.

No output is made via the COMPOSITE connector of OUTPUT 1.

Has the setting for inputting HDCP signals been made?

When [HDCP] on the System menu is set to [ON], as with output via the RGB/COMPONENT connectors, output via the COMPOSITE connector of OUTPUT 1 is stopped.

Compositing with DSK is not possible.

Is the logo or text being input to the channel specified by [Source Channel] on the DSK menu?

Also adjust [TYPE] and [Level] on the DSK menu to appropriate values matched to the source.

Fading of DSK foreground image is not possible

Is CUT selected as the transition effect?

Is [Chroma 1] or [Chroma 2] is selected as [Type] of DSK?

If you are selecting one of above, the fade in/out of foreground image is disabled. Cut in/out is applied.

No audio is output via equipment connected to OUTPUT 1/2.

Has the correct source been selected using "HDMI Output Select" on the Audio menu?

Is "Main Volume" set too low?

Is the volume level of the connected monitor set too low?

Is the connected audio device is compatible with linear PCM?

The volume level of equipment connected to AUDIO INPUT is too low.

Could you be using a connection cable that contains a resistor?

Use a connection cable that does not contain a resistor.

Video and audio timing is out of sync.

Adjust [HDMI Audio Delay] and [Audio In Delay] on the Audio menu.

A USB memory device cannot be used.

Was the USB memory device formatted on the V-40HD?

A USB memory device that has not been formatted on this product cannot be used. Also, operation has been tested for commonly available USB memory devices, but operation of all USB memory devices is not assured. Depending on the manufacturer and type of the USB memory device, correct operation may not be possible.

Switching is not complete even when the video fader is moved.

Carry out calibration of the video fader. Move video fader all the way to either the front or the back, then go to the System menu and select and execute [Video Fader Calibrate].

The panel indicators are too bright/dark.

Carry out dimmer adjustment. At the System menu, raise or lower the value of the [LED Dimmer] setting.

No labels are displayed on the preview monitor.

Has the setting for hiding labels been made?

Go to the System menu and select [PVW Label] to access the detailed setup screen, and change the setting for [Indicate] to [ON].

Nothing can be saved to MEMORY buttons.

Is memory protection turned on?

Go to the System menu and select [Memory Protect], and set it to [OFF].

No fade is applied to final output.

Is fade time set to zero?

Go to the System menu and select [Output Fade] to access the detailed setup screen, and make the setting for [Time]. No fade is applied when this parameter is set to [0.0s].

A short black images appear while switching.

On the conditions below, a short black image is inserted between 2 video images if you directly switch the video pressing the buttons in [A-BUS/PGM] section.

- When a direct switching operation is carried out while a logo/text is composited using the DSK function.
- [DSK] is selected as the display mode of preview monitor and [PST] is selected as the output source for OUTPUT 1/2.
- [DSK Source] is selected as the output source for OUTPUT 1/2.

A short black image is inserted the output if you carry out the operations below while you are compositing logo/text using the DSK.

- Switching of source channel for background or inset screen while you are using PinP and DSK.
- Switching of source channel while the transition effect is going on under the logo/text composited using the DSK.

Index

A	
A/B	31, 32
Audio	21
Audio Follow	38
Audio Source	37
AUTO OFF	13
C	
Component	20
Composite	20
D	
Delay	38
DSK	35
F	
Factory Reset	44
Fade	33
Format	41
H	
HDCP	26
HDMI	19
I	
Input Formats	24
Internal Memory	40
L	
Lip-sync	38
M	
MEMORY	40
Menu	11, 45
MIDI	53
MIDI VISUAL CONTROL	53
O	
Output Formats	25
Output Level	37
P	
PGM/PST	28
Picture-in-Picture	34
Preview Labels	43
Preview Monitor	10
Projector	22
PVW	10
R	
Remote Control	53
RGB	19
RS-232C	53
S	
Shared Input	21
Signal Flow	17
Source	19
Specifications	52
T	
Tally	23
transition effect	29
transition time	29
U	
USB Memory	41
V	
Video Fader	30



For EU Countries

This product complies with the requirements of EMC Directive 2004/108/EC.

For the USA

FEDERAL COMMUNICATIONS COMMISSION RADIO FREQUENCY INTERFERENCE STATEMENT

This equipment has been tested and found to comply with the limits for a Class B digital device, pursuant to Part 15 of the FCC Rules. These limits are designed to provide reasonable protection against harmful interference in a residential installation. This equipment generates, uses, and can radiate radio frequency energy and, if not installed and used in accordance with the instructions, may cause harmful interference to radio communications. However, there is no guarantee that interference will not occur in a particular installation. If this equipment does cause harmful interference to radio or television reception, which can be determined by turning the equipment off and on, the user is encouraged to try to correct the interference by one or more of the following measures:

- Reorient or relocate the receiving antenna.
- Increase the separation between the equipment and receiver.
- Connect the equipment into an outlet on a circuit different from that to which the receiver is connected.
- Consult the dealer or an experienced radio/TV technician for help.

This device complies with Part 15 of the FCC Rules. Operation is subject to the following two conditions:

- (1) this device may not cause harmful interference, and
- (2) this device must accept any interference received, including interference that may cause undesired operation.

This equipment requires shielded interface cables in order to meet FCC class B limit.

Any unauthorized changes or modifications not expressly approved by the party responsible for compliance could void the user's authority to operate the equipment.

For Canada

NOTICE

This Class B digital apparatus meets all requirements of the Canadian Interference-Causing Equipment Regulations.

AVIS

Cet appareil numérique de la classe B respecte toutes les exigences du Règlement sur le matériel brouilleur du Canada.

For C.A. US (Proposition 65)

WARNING

This product contains chemicals known to cause cancer, birth defects and other reproductive harm, including lead.

For the USA

DECLARATION OF CONFORMITY Compliance Information Statement

Model Name : V-40HD
Type of Equipment : Video Switcher
Responsible Party : Roland Systems Group U.S.
Address : 5100 S.Eastern Avenue, Los Angeles, CA 90040-2938, U.S.A.
Telephone : (323) 890 3700

For EU Countries



- UK** This symbol indicates that in EU countries, this product must be collected separately from household waste, as defined in each region. Products bearing this symbol must not be discarded together with household waste.
- DE** Dieses Symbol bedeutet, dass dieses Produkt in EU-Ländern getrennt vom Hausmüll gesammelt werden muss gemäß den regionalen Bestimmungen. Mit diesem Symbol gekennzeichnete Produkte dürfen nicht zusammen mit dem Hausmüll entsorgt werden.
- FR** Ce symbole indique que dans les pays de l'Union européenne, ce produit doit être collecté séparément des ordures ménagères selon les directives en vigueur dans chacun de ces pays. Les produits portant ce symbole ne doivent pas être mis au rebut avec les ordures ménagères.
- IT** Questo simbolo indica che nei paesi della Comunità europea questo prodotto deve essere smaltito separatamente dai normali rifiuti domestici, secondo la legislazione in vigore in ciascun paese. I prodotti che riportano questo simbolo non devono essere smaltiti insieme ai rifiuti domestici. Ai sensi dell'art. 13 del D.Lgs. 25 luglio 2005 n. 151.
- ES** Este símbolo indica que en los países de la Unión Europea este producto debe recogerse aparte de los residuos domésticos, tal como está regulado en cada zona. Los productos con este símbolo no se deben depositar con los residuos domésticos.
- PT** Este símbolo indica que nos países da UE, a recolha deste produto deverá ser feita separadamente do lixo doméstico, de acordo com os regulamentos de cada região. Os produtos que apresentem este símbolo não deverão ser eliminados juntamente com o lixo doméstico.
- NL** Dit symbool geeft aan dat in landen van de EU dit product gescheiden van huishoudelijk afval moet worden aangeboden, zoals bepaald per gemeente of regio. Producten die van dit symbool zijn voorzien, mogen niet samen met huishoudelijk afval worden verwijderd.
- DK** Dette symbol angiver, at i EU-lande skal dette produkt opsamles adskilt fra husholdningsaffald, som defineret i hver enkelt region. Produkter med dette symbol må ikke smides ud sammen med husholdningsaffald.
- NO** Dette symbolet indikerer at produktet må behandles som spesialavfall i EU-land, iht. til retningslinjer for den enkelte regionen, og ikke kastes sammen med vanlig husholdningsavfall. Produkter som er merket med dette symbolet, må ikke kastes sammen med vanlig husholdningsavfall.

- SE** Symbolen anger att i EU-länder måste den här produkten kasseras separat från hushållsavfall, i enlighet med varje regions bestämmelser. Produkter med den här symbolen får inte kasseras tillsammans med hushållsavfall.
- FI** Tämä merkintä ilmaisee, että tuote on EU-maissa kerättävä erillään kotitalousjätteistä kunkin alueen voimassa olevien määräysten mukaisesti. Tällä merkinnällä varustettuja tuotteita ei saa hävittää kotitalousjätteiden mukana.
- HU** Ez a szimbólum azt jelenti, hogy az Európai Unióban ezt a terméket a háztartási hulladéktól elkülönítve, az adott régióban érvényes szabályozás szerint kell gyűjteni. Az ezzel a szimbóllummal ellátott termékeket nem szabad a háztartási hulladék közé dobni.
- PL** Symbol oznacza, że zgodnie z regulacjami w odpowiednim regionie, w krajach UE produktu nie należy wyrzucać z odpadami domowymi. Produktów opatrzonych tym symbolem nie można utylizować razem z odpadami domowymi.
- CZ** Tento symbol udává, že v zemích EU musí být tento výrobek sbíráán odděleně od domácího odpadu, jak je určeno pro každý region. Výrobky nesoucí tento symbol se nesmí vyhazovat spolu s domácím odpadem.
- SK** Tento symbol vyjadruje, že v krajinách EÚ sa musí zber tohto produktu vykonávať oddelene od domového odpadu, podľa nariadení platných v konkrétnej krajine. Produkty s týmto symbolom sa nesmú vyhazovať spolu s domovým odpadom.
- EE** See sümbol näitab, et EL-i maades tuleb see toode olemprügist eraldi koguda, nii nagu on igas piirkonnas määratletud. Selle sümboliga märgitud tooteid ei tohi ära visata koos olmeprügiga.
- LT** Šis simbolis rodo, kad ES šalyse šis produktas turi būti surenkamas atskirai nuo buitinių atliekų, kaip nustatyta kiekviename regione. Šiuo simboliu paženklinėti produktai neturi būti išmetami kartu su buitiniams atliekomis.
- LV** Šis simbols norāda, ka ES valstīs šo produktu jāievāc atsevišķi no mājsaimniecības atkritumiem, kā noteikts katrā reģionā. Produkts ar šo simbolu nedrīkst izmest kopā ar mājsaimniecības atkritumiem.
- SI** Ta simbol označuje, da je treba proizvod v državah EU zbirati ločeno od gospodinjjskih odpadkov, tako kot je določeno v vsaki regiji. Proizvoda s tem znakom ni dovoljeno odlagati skupaj z gospodinjjskimi odpadki.
- GR** Το σύμβολο αυτό υποδηλώνει ότι στις χώρες της Ε.Ε. το συγκεκριμένο προϊόν πρέπει να συλλέγεται χωριστά από τα υπόλοιπα οικιακά απορρίμματα, σύμφωνα με όσα προβλέπονται σε κάθε περιοχή. Τα προϊόντα που φέρουν το συγκεκριμένο σύμβολο δεν πρέπει να απορρίπτονται μαζί με τα οικιακά απορρίμματα.

For China

有关产品中所含有害物质的说明

本资料就本公司产品中所含的特定有害物质及其安全性予以说明。
本资料适用于 2007 年 3 月 1 日以后本公司所制造的产品。

环保使用期限



此标志适用于在中国国内销售的电子信息产品，表示环保使用期限的年数。所谓环保使用期限是指在自制造日起的规定期限内，产品中所含的有害物质不致引起环境污染，不会对人身、财产造成严重的不良影响。环保使用期限仅在遵照产品使用说明书，正确使用产品的条件下才有效。不当的使用，将会导致有害物质泄漏的危险。

产品中有毒有害物质或元素的名称及含量

部件名称	有毒有害物质或元素					
	铅(Pb)	汞(Hg)	镉(Cd)	六价铬(Cr(VI))	多溴联苯(PBB)	多溴二苯醚(PBDE)
外壳(壳体)	×	○	○	○	○	○
电子部件(印刷电路板等)	×	○	×	○	○	○
附件(电源线、交流适配器等)	×	○	○	○	○	○

○：表示该有毒有害物质在该部件所有均质材料中的含量均在 SJ/T11363-2006 标准规定的限量要求以下。
×：表示该有毒有害物质至少在该部件的某一均质材料中的含量超出 SJ/T11363-2006 标准规定的限量要求。
因根据现有的技术水平，还没有什么物质能够代替它。

Roland



* 5 1 0 0 0 2 9 0 5 2 - 0 5 *