

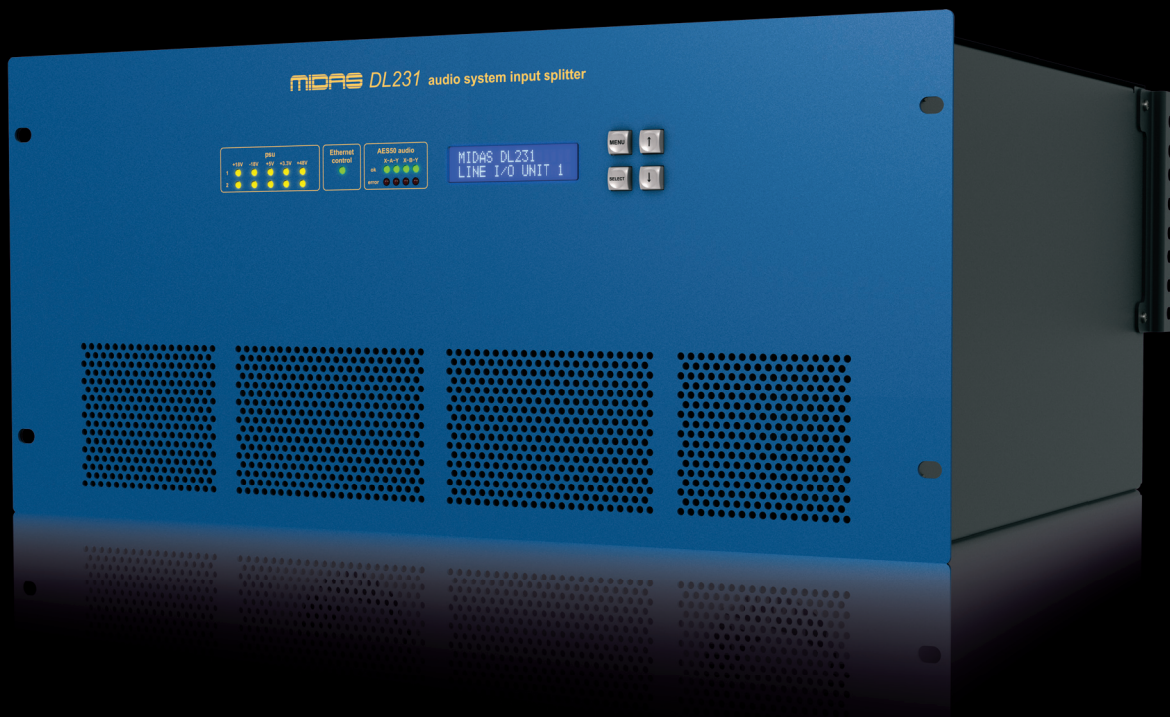

DL231

24 Input, 24 Output Active Microphone Splitter with
2 Independent MIDAS Microphone Preamplifiers per Input

Quick Start Guide (Visit midasconsoles.com for Full Manual)





EN

EN Important Safety Instructions





 Terminals marked with this symbol carry electrical current of sufficient magnitude to constitute risk of electric shock. Use only high-quality commercially-available speaker cables with plugs pre-installed. All other installation or modification should be performed only by qualified personnel.

 This symbol, wherever it appears, alerts you to the presence of uninsulated dangerous voltage inside the enclosure - voltage that may be sufficient to constitute a risk of shock.

 This symbol, wherever it appears, alerts you to important operating and maintenance instructions in the accompanying literature. Please read the manual.

 **Caution**
To reduce the risk of electric shock, do not remove the top cover (or the rear section). No user serviceable parts inside. Refer servicing to qualified personnel.

 **Caution**
To reduce the risk of fire or electric shock, do not expose this appliance to rain and moisture. The apparatus shall not be exposed to dripping or splashing liquids and no objects filled with liquids, such as vases, shall be placed on the apparatus.

 **Caution**
These service instructions are for use by qualified service personnel only. To reduce the risk of electric shock do not perform any servicing other than that contained in the operation instructions. Repairs have to be performed by qualified service personnel.

1. Read these instructions.
2. Keep these instructions.
3. Heed all warnings.
4. Follow all instructions.
5. Do not use this apparatus near water.
6. Clean only with dry cloth.
7. Do not block any ventilation openings. Install in accordance with the manufacturer's instructions.
8. Do not install near any heat sources such as radiators, heat registers, stoves, or other apparatus (including amplifiers) that produce heat.

9. Do not defeat the safety purpose of the polarized or grounding-type plug. A polarized plug has two blades with one wider than the other. A grounding-type plug has two blades and a third grounding prong. The wide blade or the third prong are provided for your safety. If the provided plug does not fit into your outlet, consult an electrician for replacement of the obsolete outlet.

10. Protect the power cord from being walked on or pinched particularly at plugs, convenience receptacles, and the point where they exit from the apparatus.

11. Use only attachments/accessories specified by the manufacturer.



12. Use only with the cart, stand, tripod, bracket, or table specified by the manufacturer, or sold with the apparatus. When a cart is used, use caution when moving the cart/apparatus combination to avoid

injury from tip-over.

13. Unplug this apparatus during lightning storms or when unused for long periods of time.

14. Refer all servicing to qualified service personnel. Servicing is required when the apparatus has been damaged in any way, such as power supply cord or plug is damaged, liquid has been spilled or objects have fallen into the apparatus, the apparatus has been exposed to rain or moisture, does not operate normally, or has been dropped.

15. The apparatus shall be connected to a MAINS socket outlet with a protective earthing connection.

16. Where the MAINS plug or an appliance coupler is used as the disconnect device, the disconnect device shall remain readily operable.



17. Correct disposal of this product: This symbol indicates that this product must not be disposed of with household waste, according to the WEEE Directive (2012/19/EU) and your national law. This product should be taken

to a collection center licensed for the recycling of waste electrical and electronic equipment (EEE). The mishandling of this type of waste could have a possible negative impact on the environment and human health due to potentially hazardous substances that are generally associated with EEE. At the same time, your cooperation in the correct disposal of this product will contribute to the efficient use of natural resources. For more information about where you can take your waste equipment for recycling, please contact your local city office, or your household waste collection service.

LEGAL DISCLAIMER

MUSIC Group accepts no liability for any loss which may be suffered by any person who relies either wholly or in part upon any description, photograph, or statement contained herein. Technical specifications, appearances and other information are subject to change without notice. All trademarks are the property of their respective owners. MIDAS, KLARK TEKNIK, TURBOSOUND, BEHRINGER, BUGERA and DDA are trademarks or registered trademarks of MUSIC Group IP Ltd. © MUSIC Group IP Ltd. 2014 All rights reserved.

LIMITED WARRANTY

For the applicable warranty terms and conditions and additional information regarding MUSIC Group's Limited Warranty, please see complete details online at music-group.com/warranty.

ES Instrucciones de seguridad





 Las terminales marcadas con este símbolo transportan corriente eléctrica de magnitud suficiente como para constituir un riesgo de descarga eléctrica. Utilice solo cables de altavoz de alta calidad con clavijas TS de 6,3 mm pre-instaladas (puede adquirirlos en comercios especializados en audio). Cualquier otra instalación o modificación debe ser realizada únicamente por un técnico cualificado.

 Este símbolo, siempre que aparece, le advierte de la presencia de voltaje peligroso sin aislar dentro de la caja; este voltaje puede ser suficiente para constituir un riesgo de descarga.

 Este símbolo, siempre que aparece, le advierte sobre instrucciones operativas y de mantenimiento que aparecen en la documentación adjunta. Por favor, lea el manual.

 **Atención**
Para reducir el riesgo de descarga eléctrica, no quite la tapa (o la parte posterior). No hay piezas en el interior del equipo que puedan ser reparadas por el usuario. Si es necesario, póngase en contacto con personal cualificado.

 **Atención**
Para reducir el riesgo de incendio o descarga eléctrica, no exponga este aparato a la lluvia, humedad o alguna otra fuente que pueda salpicar o derramar algún líquido sobre el aparato. No coloque ningún tipo de recipiente para líquidos sobre el aparato.

 **Atención**
Las instrucciones de servicio deben llevarlas a cabo exclusivamente personal cualificado. Para evitar el riesgo de una descarga eléctrica, no realice reparaciones que no se encuentren descritas en el manual de operaciones. Las reparaciones deben ser realizadas exclusivamente por personal cualificado.

1. Lea las instrucciones.
2. Conserve estas instrucciones.
3. Preste atención a todas las advertencias.
4. Siga todas las instrucciones.
5. No use este aparato cerca del agua.
6. Limpie este aparato con un paño seco.
7. No bloquee las aberturas de ventilación. Instale el equipo de acuerdo con las instrucciones del fabricante.
8. No instale este equipo cerca de fuentes de calor tales como radiadores, acumuladores de calor, estufas u otros aparatos (incluyendo amplificadores) que puedan producir calor.

9. No elimine o deshabilite nunca la conexión a tierra del aparato o del cable de alimentación de corriente. Un enchufe polarizado tiene dos polos, uno de los cuales tiene un contacto más ancho que el otro. Una clavija con puesta a tierra dispone de tres contactos: dos polos y la puesta a tierra. El contacto ancho y el tercer contacto, respectivamente, son los que garantizan una mayor seguridad. Si el enchufe suministrado con el equipo no concuerda con la toma de corriente, consulte con un electricista para cambiar la toma de corriente obsoleta.

10. Coloque el cable de suministro de energía de manera que no pueda ser pisado y que esté protegido de objetos afilados. Asegúrese de que el cable de suministro de energía esté protegido, especialmente en la zona de la clavija y en el punto donde sale del aparato.

11. Use únicamente los dispositivos o accesorios especificados por el fabricante.



12. Use únicamente la carretilla, plataforma, trípode, soporte o mesa especificados por el fabricante o suministrados junto con el equipo. Al transportar el equipo, tenga cuidado para evitar daños y caídas al tropezar con algún obstáculo.

13. Desenchufe el equipo durante tormentas o si no va a utilizarlo durante un periodo largo.

14. Confíe las reparaciones únicamente a servicios técnicos cualificados. La unidad requiere mantenimiento siempre que haya sufrido algún daño, si el cable de suministro de energía o el enchufe presentaran daños, se hubiera derramado un líquido o hubieran caído objetos dentro del equipo, si el aparato hubiera estado expuesto a la humedad o la lluvia, si ha dejado de funcionar de manera normal o si ha sufrido algún golpe o caída.

15. Al conectar la unidad a la toma de corriente eléctrica asegúrese de que la conexión disponga de una unión a tierra.

16. Si el enchufe o conector de red sirve como único medio de desconexión, éste debe ser accesible fácilmente.



17. Cómo debe deshacerse de este aparato: Este símbolo indica que este aparato no debe ser tratado como basura orgánica, según lo indicado en la Directiva WEEE (2012/19/EU) y a las normativas aplicables en su país.

En lugar de ello deberá llevarlo al punto limpio más cercano para el reciclaje de sus elementos eléctricos / electrónicos (EEE). Al hacer esto estará ayudando a prevenir las posibles consecuencias negativas para el medio ambiente y la salud que podrían ser provocadas por una gestión inadecuada de este tipo de aparatos. Además, el reciclaje de materiales ayudará a conservar los recursos naturales. Para más información acerca del reciclaje de este aparato, póngase en contacto con el Ayuntamiento de su ciudad o con el punto limpio local.

NEGACIÓN LEGAL

MUSIC Group no admite ningún tipo de responsabilidad por cualquier daño o pérdida que pudiera sufrir cualquier persona por confiar total o parcialmente en la descripciones, fotografías o afirmaciones contenidas en este documento. Las especificaciones técnicas, imágenes y otras informaciones contenidas en este documento están sujetas a modificaciones sin previo aviso. Todas las marcas comerciales que aparecen aquí son propiedad de sus respectivos dueños. MIDAS, KLARK TEKNIK, TURBOSOUND, BEHRINGER, BUGERA y DDA son marcas comerciales o marcas registradas de MUSIC Group IP Ltd. © MUSIC Group IP Ltd. 2014 Reservados todos los derechos.

GARANTÍA LIMITADA

Si quiere conocer los detalles y condiciones aplicables de la garantía así como información adicional sobre la Garantía limitada de MUSIC group, consulte online toda la información en la web music-group.com/warranty.

EN

ES

FR Consignes de sécurité



Les points repérés par ce symbole portent une tension électrique suffisante pour constituer un risque d'électrocution.

Utilisez uniquement des câbles d'enceintes de haute qualité disponibles dans les points de vente avec les connecteurs Jack mono 6,35 mm déjà installés. Toute autre installation ou modification doit être effectuée uniquement par un personnel qualifié.

Ce symbole avertit de la présence d'une tension dangereuse et non isolée à l'intérieur de l'appareil - elle peut provoquer des chocs électriques.

Attention
Ce symbole signale les consignes d'utilisation et d'entre ! Tien importantes dans la documentation fournie. Lisez les consignes de sécurité du manuel d'utilisation de l'appareil.

Attention
Pour éviter tout risque de choc électrique, ne pas ouvrir le capot de l'appareil ni démonter le panneau arrière. L'intérieur de l'appareil ne possède aucun élément réparable par l'utilisateur. Laisser toute réparation à un professionnel qualifié.

Attention
Pour réduire les risques de feu et de choc électrique, n'exposez pas cet appareil à la pluie, à la moisissure, aux gouttes ou aux éclaboussures. Ne posez pas de récipient contenant un liquide sur l'appareil (un vase par exemple).

Attention
Ces consignes de sécurité et d'entretien sont destinées à un personnel qualifié. Pour éviter tout risque de choc électrique, n'effectuez aucune réparation sur l'appareil qui ne soit décrite par le manuel d'utilisation. Les éventuelles réparations doivent être effectuées uniquement par un technicien spécialisé.

1. Lisez ces consignes.
2. Conservez ces consignes.
3. Respectez tous les avertissements.
4. Respectez toutes les consignes d'utilisation.
5. N'utilisez jamais l'appareil à proximité d'un liquide.
6. Nettoyez l'appareil avec un chiffon sec.
7. Veillez à ne pas empêcher la bonne ventilation de l'appareil via ses ouïes de ventilation. Respectez les consignes du fabricant concernant l'installation de l'appareil.
8. Ne placez pas l'appareil à proximité d'une source de chaleur telle qu'un chauffage, une cuisinière ou tout appareil dégageant de la chaleur (y compris un ampli de puissance).

9. Ne supprimez jamais la sécurité des prises bipolaires ou des prises terre. Les prises bipolaires possèdent deux contacts de largeur différente. Le plus large est le contact de sécurité. Les prises terre possèdent deux contacts plus une mise à la terre servant de sécurité. Si la prise du bloc d'alimentation ou du cordon d'alimentation fourni ne correspond pas à celles de votre installation électrique, faites appel à un électricien pour effectuer le changement de prise.

10. Installez le cordon d'alimentation de telle façon que personne ne puisse marcher dessus et qu'il soit protégé d'arêtes coupantes. Assurez-vous que le cordon d'alimentation est suffisamment protégé, notamment au niveau de sa prise électrique et de l'endroit où il est relié à l'appareil; cela est également valable pour une éventuelle rallonge électrique.

11. Utilisez exclusivement des accessoires et des appareils supplémentaires recommandés par le fabricant.



12. Utilisez exclusivement des chariots, des diables, des présentoirs, des pieds et des surfaces de travail recommandés par le fabricant ou livrés avec le produit.

Déplacez précautionneusement tout chariot ou diable chargé pour éviter d'éventuelles blessures en cas de chute.

13. Débranchez l'appareil de la tension secteur en cas d'orage ou si l'appareil reste inutilisé pendant une longue période de temps.

14. Les travaux d'entretien de l'appareil doivent être effectués uniquement par du personnel qualifié. Aucun entretien n'est nécessaire sauf si l'appareil est endommagé de quelque façon que ce soit (dommages sur le cordon d'alimentation ou la prise par exemple), si un liquide ou un objet a pénétré à l'intérieur du châssis, si l'appareil a été exposé à la pluie ou à l'humidité, s'il ne fonctionne pas correctement ou à la suite d'une chute.

15. L'appareil doit être connecté à une prise secteur dotée d'une protection par mise à la terre.

16. La prise électrique ou la prise IEC de tout appareil dénué de bouton marche/arrêt doit rester accessible en permanence.



17. Mise au rebut appropriée de ce produit: Ce symbole indique qu'en accord avec la directive DEEE (2012/19/EU) et les lois en vigueur dans votre pays, ce produit ne doit pas être jeté avec les déchets ménagers. Ce produit doit être déposé dans un point de collecte agréé pour le recyclage des déchets d'équipements électriques et électroniques (EEE). Une mauvaise manipulation de ce type de déchets pourrait avoir un impact négatif sur l'environnement et la santé à cause des substances potentiellement dangereuses généralement associées à ces équipements. En même temps, votre coopération dans la mise au rebut de ce produit contribuera à l'utilisation efficace des ressources naturelles. Pour plus d'informations sur l'endroit où vous pouvez déposer vos déchets

d'équipements pour le recyclage, veuillez contacter votre mairie ou votre centre local de collecte des déchets.

DÉNI LÉGAL

MUSIC Group ne peut être tenu pour responsable pour toute perte pouvant être subie par toute personne se fiant en partie ou en totalité à toute description, photographie ou affirmation contenue dans ce document. Les caractéristiques, l'apparence et d'autres informations peuvent faire l'objet de modifications sans notification. Toutes les marques appartiennent à leurs propriétaires respectifs. MIDAS, KLARK TEKNIK, TURBOSOUND, BEHRINGER, BUGERA et DDA sont des marques ou marques déposées de MUSIC Group IP Ltd. © MUSIC Group IP Ltd. 2014 Tous droits réservés.

GARANTIE LIMITÉE

Pour connaître les termes et conditions de garantie applicables, ainsi que les informations supplémentaires et détaillées sur la Garantie Limitée de MUSIC Group, consultez le site Internet music-group.com/warranty.

DE Wichtige Sicherheitshinweise



Vorsicht
Die mit dem Symbol markierten Anschlüsse führen so viel Spannung, dass die Gefahr eines Stromschlags besteht. Verwenden Sie nur hochwertige, im Handel erhältliche Lautsprecherkabel mit vorinstallierten 6,3 mm TSS Steckern. Alle anderen Installationen oder Modifikationen sollten nur von qualifiziertem Fachpersonal ausgeführt werden.

Achtung
Um eine Gefährdung durch Stromschlag auszuschließen, darf die Geräteabdeckung bzw. Geräterückwand nicht abgenommen werden. Im Innern des Geräts befinden sich keine vom Benutzer reparierbaren Teile. Reparaturarbeiten dürfen nur von qualifiziertem Personal ausgeführt werden.

Achtung
Um eine Gefährdung durch Feuer bzw. Stromschlag auszuschließen, darf dieses Gerät weder Regen oder Feuchtigkeit ausgesetzt werden noch sollten Spritzwasser oder tropfende Flüssigkeiten in das Gerät gelangen können. Stellen Sie keine mit Flüssigkeit gefüllten Gegenstände, wie z. B. Vasen, auf das Gerät.

Achtung
Die Service-Hinweise sind nur durch qualifiziertes Personal zu befolgen. Um eine Gefährdung durch Stromschlag zu vermeiden, führen Sie bitte keinerlei Reparaturen an dem Gerät durch, die nicht in der Bedienungsanleitung beschrieben sind. Reparaturen sind nur von qualifiziertem Fachpersonal durchzuführen.

1. Lesen Sie diese Hinweise.
2. Bewahren Sie diese Hinweise auf.
3. Beachten Sie alle Warnhinweise.
4. Befolgen Sie alle Bedienungshinweise.
5. Betreiben Sie das Gerät nicht in der Nähe von Wasser.
6. Reinigen Sie das Gerät mit einem trockenen Tuch.
7. Blockieren Sie nicht die Belüftungsschlitze. Beachten Sie beim Einbau des Gerätes die Herstellerhinweise.
8. Stellen Sie das Gerät nicht in der Nähe von Wärmequellen auf. Solche Wärmequellen sind z. B. Heizkörper, Herde oder andere Wärme erzeugende Geräte (auch Verstärker).
9. Entfernen Sie in keinem Fall die Sicherheitsvorrichtung von Zweipol- oder geerdeten Steckern. Ein Zweipolstecker hat zwei unterschiedlich breite Steckkontakte. Ein geerdeter Stecker hat zwei Steckkontakte und einen dritten Erdungskontakt. Der breitere Steckkontakt oder der zusätzliche Erdungskontakt dient Ihrer Sicherheit. Falls das

mitgelieferte Steckerformat nicht zu Ihrer Steckdose passt, wenden Sie sich bitte an einen Elektriker, damit die Steckdose entsprechend ausgetauscht wird.

10. Verlegen Sie das Netzkabel so, dass es vor Tritten und scharfen Kanten geschützt ist und nicht beschädigt werden kann. Achten Sie bitte insbesondere im Bereich der Stecker, Verlängerungskabel und an der Stelle, an der das Netzkabel das Gerät verlässt, auf ausreichenden Schutz.

11. Das Gerät muss jederzeit mit intaktem Schutzleiter an das Stromnetz angeschlossen sein.

12. Sollte der Hauptnetzstecker oder eine Gerätesteckdose die Funktionseinheit zum Abschalten sein, muss diese immer zugänglich sein.

13. Verwenden Sie nur Zusatzgeräte/Zubehörteile, die laut Hersteller geeignet sind.



14. Verwenden Sie nur Wagen, Standvorrichtungen, Stative, Halter oder Tische, die vom Hersteller benannt oder im Lieferumfang des Geräts enthalten sind. Falls Sie einen

Wagen benutzen, seien Sie vorsichtig beim Bewegen der Wagen-Gerätkombination, um Verletzungen durch Stolpern zu vermeiden.

15. Ziehen Sie den Netzstecker bei Gewitter oder wenn Sie das Gerät längere Zeit nicht benutzen.

16. Lassen Sie alle Wartungsarbeiten nur von qualifiziertem Service-Personal ausführen. Eine Wartung ist notwendig, wenn das Gerät in irgendeiner Weise beschädigt wurde (z. B. Beschädigung des Netzkabels oder Steckers), Gegenstände oder Flüssigkeit in das Geräteinnere gelangt sind, das Gerät Regen oder Feuchtigkeit ausgesetzt wurde, das Gerät nicht ordnungsgemäß funktioniert oder auf den Boden gefallen ist.



17. Korrekte Entsorgung dieses Produkts: Dieses Symbol weist darauf hin, das Produkt entsprechend der WEEE Richtlinie (2012/19/EU) und der jeweiligen nationalen Gesetze nicht zusammen mit Ihren

Haushaltsabfällen zu entsorgen. Dieses Produkt sollte bei einer autorisierten Sammelstelle für Recycling elektrischer und elektronischer Geräte (EEE) abgegeben werden. Wegen bedenklicher Substanzen, die generell mit elektrischen und elektronischen Geräten in Verbindung stehen, könnte eine unsachgemäße Behandlung dieser Abfallart eine negative Auswirkung auf Umwelt und Gesundheit haben. Gleichzeitig gewährleistet Ihr Beitrag zur richtigen Entsorgung dieses Produkts die effektive Nutzung natürlicher Ressourcen. Für weitere Informationen zur Entsorgung Ihrer Geräte bei einer Recycling-Stelle nehmen Sie bitte Kontakt zum zuständigen städtischen Büro, Entsorgungsamt oder zu Ihrem Haushaltsabfallentsorger auf.

HAFTUNGS AUSSCHLUSS

MUSIC Group übernimmt keine Haftung für Verluste, die Personen entstanden sind, die sich ganz oder teilweise auf hier enthaltene Beschreibungen, Fotos oder Aussagen verlassen haben. Technische Daten, Erscheinungsbild und andere Informationen können ohne vorherige Ankündigung geändert werden. Alle Warenzeichen sind Eigentum der jeweiligen Inhaber. MIDAS, KLARK TEKNIK, TURBOSOUND, BEHRINGER, BUGERA und DDA sind Warenzeichen oder eingetragene Warenzeichen der MUSIC Group IP Ltd. © MUSIC Group IP Ltd. 2014 Alle Rechte vorbehalten.

BESCHRÄNKTE GARANTIE

Die geltenden Garantiebedingungen und zusätzliche Informationen bezüglich der von MUSIC Group gewährten beschränkten Garantie finden Sie online unter music-group.com/warranty.

PT Instruções de Segurança Importantes



Aviso!
Terminais marcados com o símbolo carregam corrente elétrica de magnitude suficiente para constituir um risco de choque elétrico. Use apenas cabos de alto-falantes comercialmente disponíveis de alta qualidade com plugues TS de ¼" pré-instalados. Todas as outras instalações e modificações devem ser efetuadas por pessoas qualificadas.

Este símbolo, onde quer que o encontre, alerta-o para a leitura das instruções de manuseamento que acompanham o equipamento. Por favor leia o manual de instruções.

Atenção
De forma a diminuir o risco de choque elétrico, não remover a cobertura (ou a secção de trás). Não existem peças substituíveis por parte do utilizador no seu interior. Para esse efeito recorrer a um técnico qualificado.

Atenção
Para reduzir o risco de incêndios ou choques elétricos o aparelho não deve ser exposto à chuva nem à humidade. Além disso, não deve ser sujeito a salpicos, nem devem ser colocados em cima do aparelho objectos contendo líquidos, tais como jarras.

Atenção
Estas instruções de operação devem ser utilizadas, em exclusivo, por técnicos de assistência qualificados. Para evitar choques elétricos não proceda a reparações ou intervenções, que não as indicadas nas instruções de operação, salvo se possuir as qualificações necessárias. Para evitar choques elétricos não proceda a reparações ou intervenções, que não as indicadas nas instruções de operação. Só o deverá fazer se possuir as qualificações necessárias.

1. Leia estas instruções.
2. Guarde estas instruções.
3. Preste atenção a todos os avisos.
4. Siga todas as instruções.
5. Não utilize este dispositivo perto de água.
6. Limpe apenas com um pano seco.
7. Não obstrua as entradas de ventilação. Instale de acordo com as instruções do fabricante.
8. Não instale perto de quaisquer fontes de calor tais como radiadores, bocas de ar quente, fogões de sala ou outros aparelhos (incluindo amplificadores) que produzam calor.
9. Não anule o objectivo de segurança das fichas polarizadas ou do tipo de ligação à terra. Uma ficha polarizada dispõe de duas palhetas sendo uma mais larga do que a outra. Uma ficha do tipo ligação à terra dispõe

de duas palhetas e um terceiro dente de ligação à terra. A palheta larga ou o terceiro dente são fornecidos para sua segurança. Se a ficha fornecida não encaixar na sua tomada, consulte um electricista para a substituição da tomada obsoleta.

10. Proteja o cabo de alimentação de pisadelas ou apertos, especialmente nas fichas, extensões, e no local de saída da unidade. Certifique-se de que o cabo eléctrico está protegido. Verifique particularmente nas fichas, nos receptáculos e no ponto em que o cabo sai do aparelho.

11. O aparelho tem de estar sempre conectado à rede eléctrica com o condutor de protecção intacto.

12. Se utilizar uma ficha de rede principal ou uma tomada de aparelhos para desligar a unidade de funcionamento, esta deve estar sempre acessível.

13. Utilize apenas ligações/acessórios especificados pelo fabricante.



14. Utilize apenas com o carrinho, estrutura, tripé, suporte, ou mesa especificados pelo fabricante ou vendidos com o dispositivo. Quando utilizar um carrinho, tenha cuidado ao

mover o conjunto carrinho/dispositivo para evitar danos provocados pela terpidação.

15. Desligue este dispositivo durante as trovoadas ou quando não for utilizado durante longos períodos de tempo.

16. Qualquer tipo de reparação deve ser sempre efectuado por pessoal qualificado. É necessária uma reparação sempre que a unidade tiver sido de alguma forma danificada, como por exemplo: no caso do cabo de alimentação ou ficha se encontrarem danificados; na eventualidade de líquido ter sido derramado ou objectos terem caído para dentro do dispositivo; no caso da unidade ter estado exposta à chuva ou à humidade; se esta não funcionar normalmente, ou se tiver caído.



17. Correcta eliminação deste produto: este símbolo indica que o produto não deve ser eliminado juntamente com os resíduos domésticos, segundo a Directiva REEE (2012/19/EU) e a legislação nacional. Este produto deverá

ser levado para um centro de recolha licenciado para a reciclagem de resíduos de equipamentos eléctricos e electrónicos (EEE). O tratamento incorrecto deste tipo de resíduos pode ter um eventual impacto negativo no ambiente e na saúde humana devido a substâncias potencialmente perigosas que estão geralmente associadas aos EEE. Ao mesmo tempo, a sua colaboração para a eliminação correcta deste produto irá contribuir para a utilização eficiente dos recursos naturais. Para mais informação acerca dos locais onde poderá deixar o seu equipamento usado para reciclagem, é favor contactar os serviços municipais locais, a entidade de gestão de resíduos ou os serviços de recolha de resíduos domésticos.

LEGAL RENUNCIANTE

O MUSIC Group não se responsabiliza por perda alguma que possa ser sofrida por qualquer pessoa que dependa, seja de maneira completa ou parcial, de qualquer descrição, fotografia, ou declaração aqui contidas. Dados técnicos, aparências e outras informações estão sujeitas a modificações sem aviso prévio. Todas as marcas são propriedade de seus respectivos donos. MIDAS, KLARK TEKNIK, TURBOSOUND, BEHRINGER, BUGERA e DDA são marcas ou marcas registradas do MUSIC Group IP Ltd. © MUSIC Group IP Ltd. 2014 Todos direitos reservados.

GARANTIA LIMITADA

Para obter os termos de garantia aplicáveis e condições e informações adicionais a respeito da garantia limitada do MUSIC group, favor verificar detalhes na integra através do website music-group.com/warranty.

JP 安全にお使いいただくために



注意
感電の恐れがありますので、カバーやその他の部品を取り外したり、開けたりしないでください。高品質なプロ用スピーカーケーブル (¼" TS 標準ケーブルおよびツイスト ロッキング プラグケーブル) を使用してください。

注意
火事および感電の危険を防ぐため、本装置を水分や湿気のあるところには設置しないで下さい。装置には決して水分がかからないように注意し、花瓶など水分を含んだものは、装置の上には置かないようにしてください。

注意
このマークが表示されている箇所には、内部に高圧電流が生じています。手を触れると感電の恐れがあります。

注意
取り扱いとお手入れの方法についての重要な説明が付属の取扱説明書に記載されています。ご使用前に良くお読みください。

- 注意**
1. 取扱説明書を通してご覧ください。
 2. 取扱説明書を大切に保管してください。
 3. 警告に従ってください。
 4. 指示に従ってください。
 5. 本機を水の近くで使用しないでください。
 6. お手入れの際は常に乾燥した布巾を使ってください。
 7. 本機は、取扱説明書の指示に従い、適切な換気を妨げない場所に設置してください。取扱説明書に従って設置してください。
 8. 本機は、電気ヒーターや温風機器、ストーブ、調理台やアンプといった熱源から離して設置してください。

9. 二極式プラグおよびアースタイプ (三芯) プラグの安全ピンは取り外さないでください。二極式プラグにはピンが二本ついており、そのうち一本はもう一方よりも幅が広がっています。アースタイプの三芯プラグには二本のピンに加えてアース用のピンが一本ついてます。これらの幅の広いピン、およびアースピンは、安全のためのものです。備え付けのプラグが、お使いのコンセントの形状と異なる場合は、電器技師に相談してコンセントの交換をして下さい。

10. 電源コードを踏みつけたり、挟んだりしないようご注意ください。電源コードやプラグ、コンセント及び製品との接続には十分にご注意ください。

11. すべての装置の接地 (アース) が確保されていることを確認して下さい。



12. 電源タップや電源プラグは電源遮断機として利用されている場合には、これが直ぐに操作できるように手元に設置して下さい。

13. 付属品は本機製造元が指定したもののみをお使いください。

14. カートスタンド、三脚、ブラケット、テーブルなどは、本機製造元が指定したもの、もしくは本機の付属品となるもののみをお使いください。カートを使用時の運搬の際は、器具の落下による怪我に十分ご注意ください。

15. 雷雨の場合、もしくは長期間ご使用にならない場合は、電源プラグをコンセントから抜いてください。

16. 故障の際は当社指定のサービス技術者にお問い合わせください。電源コードもしくはプラグの損傷、液体の装置内への浸入、装置の上に物が落下した場合、雨や湿気に装置が晒されてしまった場合、正常に作動しない場合、もしくは装置を地面に落下させてしまった場合など、いかなる形であれ装置に損傷が加わった場合は、装置の修理・点検を受けてください。



17. 本製品に電源コードが付属されている場合、付属の電源コードは本製品以外ではご使用いただけません。電源コードは必ず本製品に付属された電源コードのみご使用ください。

法的放棄

ここに含まれる記述、写真、意見の全体または一部に依拠して、いかなる人が損害を生じさせた場合にも、MUSIC Group は一切の賠償責任を負いません。技術仕様、外観およびその他の情報は予告なく変更になる場合があります。商標はすべて、それぞれの所有者に帰属します。MIDAS、KLARK TEKNIK、TURBOSOUND、BEHRINGER、BUGERA および DDA は MUSIC Group IP Ltd. の商標または登録商標です。© MUSIC Group IP Ltd. 2014 無断転用禁止。

限定保証

適用される保証条件と MUSIC Group の限定保証に関する概要については、オンライン上 music-group.com/warranty にて詳細をご確認ください。

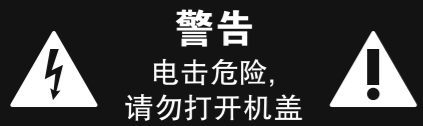
CN 其他的重要信息

 带有此标志的终端设备具有强大的电流, 存在触电危险。仅限使用带有 ¼" TS 或扭锁式插头的高品质专业扬声器线。所有的安装或调整均须由合格的专业人员进行。

 此标志提醒您, 产品内存在未绝缘的危险电压, 有触电危险。

 此标志提醒您查阅所附的重要的使用及维修说明。请阅读有关手册。

 **小心**
为避免触电危险, 请勿打开机顶盖 (或背面挡板)。设备内没有可供用户维修使用的部件。请将维修事项交由合格的专业人员进行。

 **小心**
为避免着火或触电危险, 请勿将此设备置于雨淋或潮湿中。此设备也不可受液体滴溅, 盛有液体的容器也不可置于其上, 如花瓶等。

 **小心**
维修说明仅是给合格的专业维修人员使用的。为避免触电危险, 除了使用说明书提到的以外, 请勿进行任何其它维修。所有维修均须由合格的专业人员进行。

1. 请阅读这些说明。
2. 请妥善保存这些说明。
3. 请注意所有的警示。
4. 请遵守所有的说明。
5. 请勿在靠近水的地方使用本产品。
6. 请用干布清洁本产品。
7. 请勿堵塞通风口。安装本产品时请遵照厂家的说明。
8. 请勿将本产品安装在热源附近, 如暖气片, 炉子或其它产生热量的设备 (包括功放器)。
9. 请勿移除极性插头或接地插头的安全装置。接地插头是由两个插塞接点及一个接地头构成。若随货提供的插头不适合您的插座, 请找电工更换一个合适的插座。
10. 妥善保护电源线, 使其不被践踏或刺破, 尤其注意电源插头、多用途插座及设备连接处。

11. 请只使用厂家指定的附属设备和配件。



12. 请只使用厂家指定的或随货销售的手推车, 架子, 三角架, 支架和桌子。若使用手推车来搬运设备, 请注意安全放置设备, 以避免手推车和设备

倾倒而受伤。

13. 遇闪电雷鸣或长期不使用本设备时, 请拔出电源插头。

14. 所有维修均须由合格的维修人员进行。设备受损时需进行维修, 例如电源线或电源插头受损, 液体流入或异物落入设备内, 设备遭雨淋或受潮, 设备不能正常运作或被摔坏。

15. 本设备连接电源时一定要接地保护。



16. 若电源插头或器具耦合器用作断电装置, 应当保证它们处于随时可方便操作状态。

17. 本产品仅适用于海拔 2000 米以下地区, 本产品仅适用于非热带气候条件下。

**法律声明**

对于任何因在此说明书提到的全部或部份描述、图片或声明而造成的损失, MUSIC Group 不负任何责任。技术参数和外观若有更改, 恕不另行通知。所有的商标均为其各自所有者的财产。MIDAS, KLARK TEKNIK, TURBOSOUND, BEHRINGER, BUGERA 和 DDA 是 MUSIC Group IP Ltd. 公司的商标或注册商标。© MUSIC Group IP Ltd. 2014 版权所有。

保修条款

有关音乐集团保修的适用条款及其它相关信息, 请登陆 music-group.com/warranty 网站查看完整的详细信息。

1. Introduction

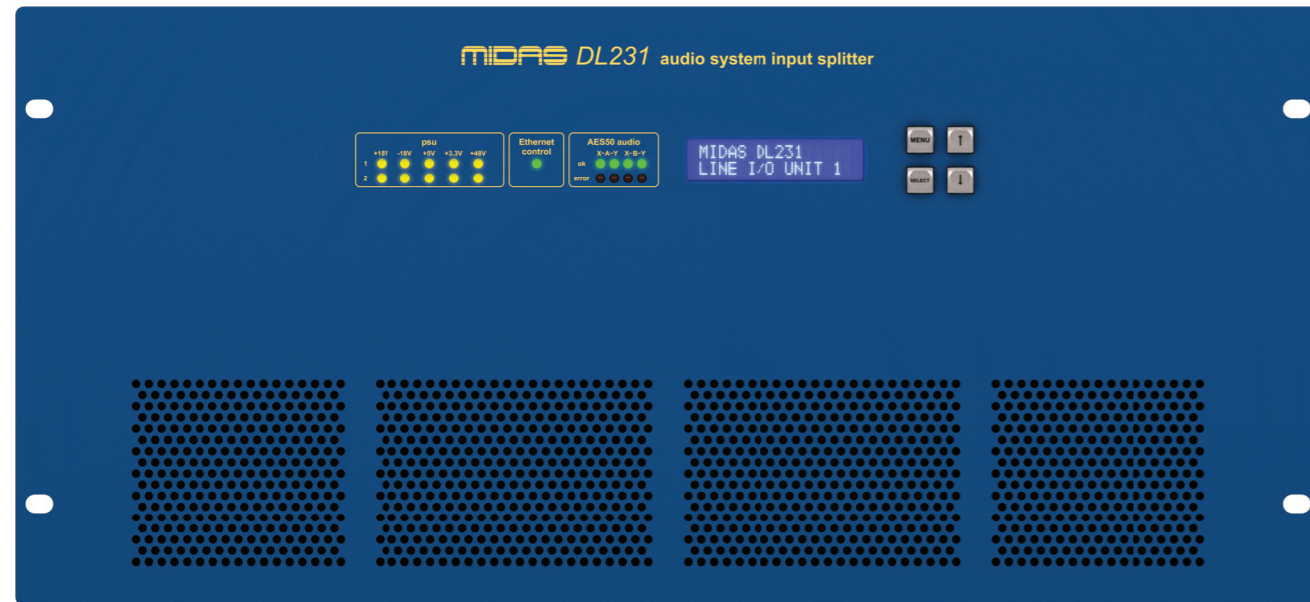

The DL231 - front panel

Welcome!

Thank you for purchasing the DL231 Audio System I/O unit.

The MIDAS DL231 Audio System I/O unit is housed in a rugged 19" 2U rack-mount chassis with cosmetic trim, suitable for use and storage in a road flight case.

All user interface controls and feedback are located on the front panel. User interface controls are laid out for ease of operation with consideration for the amount of user feedback required. All switches are high quality momentary type with integral blue LED illumination and printed switch caps.

All primary connectors are on the rear of the unit. All inputs and outputs are on balanced XLR connectors. All analogue audio inputs and outputs are tolerant of 48 V connection and short circuit protected. The DL231 uses Neutrik XLR connections.

The DL231 I/O unit is a mixed technology product combining analogue and digital circuitry. These circuit types are combined on the input and output cards using multi-layer horizontal PCBs. Extreme care has been taken when planning and executing the PCB layout to maintain good grounding and analogue/digital separation.

The DL231 unit uses proven technology from the DL251 I/O unit from the current MIDAS range. The analogue input and output cards are identical, and the CPU card is a modified version of the one used in the DL251.

The user interface software is based on the same menu system currently used on existing MIDAS I/O units and has provision for all of the functions these units can perform.

Equipped with 48 channels of MIDAS premium mic-pre amplifiers with 2.5 dB ultra precise gain steps, the DL231 unit is an ideal partner for all MIDAS digital consoles (especially the XL8, PRO3/6/9 and PRO X consoles), significantly increasing mixable mic inputs.

Integration Within The MIDAS Product Range

Styled to match existing MIDAS console livery, MIDAS high performance I/O has never been easier or more cost effective.

Features

- 2 award-winning MIDAS microphone preamplifiers per channel with switchable +48 V phantom power
- 2 dual redundant AES50 network ports with independent phase-locked loop synchronisation
- 24 electronically balanced output channels can be sourced from microphone preamplifiers or AES50 ports
- Remote operation up to 100 m via CAT5/5e cable
- 24 bit audio operation with 96 kHz sample rate
- All settings programmable from front panel controls or console
- PSU status indicator LEDs and configuration LCD display on front panel
- Features Neutrik EtherCON* AES50 network ports
- Rugged 5U rackmount chassis for durability in portable applications
- Dual redundant auto-ranging universal switch-mode power supplies
- 3-Year Warranty Program**
- Designed and engineered in England

*All third-party trademarks are the property of their respective owners. Their use neither constitutes a claim of the trademark nor affiliation of the trademark owners with MUSIC Group. Product names are mentioned solely as a reference for compatibility, effects and/or components.
**Warranty details can be found at music-group.com.

About this manual

This is the operation manual for the DL231 I/O unit. This manual is intended to help get your unit installed and in operation as quickly as possible by giving you unpacking, installation, connection, setting up and operating instructions. To help familiarise you with the DL231, there is a description of the front and rear panels, along with easy-to-follow user instructions.

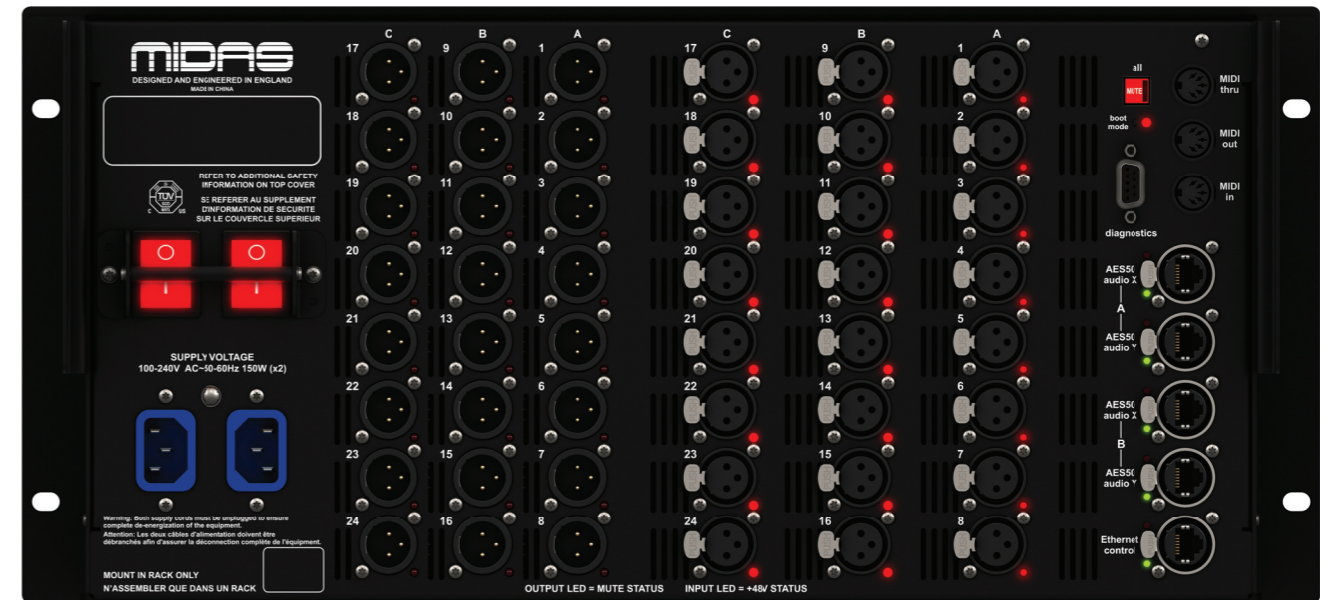

The DL231 - rear panel

2. Getting Started

This section shows you how to unpack, install, connect up, switch on and configure the DL231 I/O unit.



This equipment is supplied by a mains voltage that can cause electric shock injury.

Before installing, setting up or operating this equipment, make sure that you have read and fully understand all of this section and the "Important safety instructions" at the front of this manual. Refer to additional safety information on the top cover of the unit.

Unpacking

Carefully unpack your DL231 I/O unit. Then, inspect the DL231 I/O unit carefully for any signs of damage that may have occurred during transit and notify the courier immediately if you discover any.

Check the contents of your DL231 I/O unit equipment package. If there are any parts missing, incorrect or faulty, please contact your local distributor or MIDAS at the address at the front of this manual.

Please retain the original packing in case you should need to return the equipment to the manufacturer or supplier, or transport or ship the unit later.

Installation

Before installing and operating this equipment, make sure it is correctly connected to the protective earth conductor of the mains voltage supply socket outlet through each mains lead.

Ideally a cool area is preferred, away from power distribution equipment or other potential sources of interference.

Do not install the equipment in places of poor ventilation.

Do not install this equipment in a location subjected to excessive heat, dust or mechanical vibration. Allow for adequate ventilation around the equipment, making sure that its fans and vents are not obstructed. Whenever possible, keep the equipment out of direct sunlight.

Mount in rack only.

Power

The internal power supplies are of the switch mode type that automatically senses the incoming mains voltage and will work where the nominal voltage is in the range 100 VAC to 240 VAC.

The correct leads for connection in the area to which the unit was shipped are supplied with the unit. The equipment should only be plugged into the mains outlets using the supplied leads.

Make sure the plug fitted on the supplied mains cable is securely fitted to the mains IEC connector on the unit. When fitting or removing a plug, always hold the plug itself and never use the cable, as this may damage it. Never insert or remove an electric plug with wet hands.

Handling the equipment

When lifting or moving the equipment, always take its size and weight into consideration.

Completely isolate the equipment electrically and disconnect all cables from the equipment before moving it.

Do not insert your fingers or hands in any gaps or openings on the equipment, for example, vents.

Electric fields

In accordance with Part 15 of the FCC Rules & Regulations, "... changes or modifications not expressly approved by the party responsible for compliance could void the user's authority to operate the equipment."

Should this product be used in an electromagnetic field that is amplitude modulated by an audio frequency signal (20 Hz to 20 kHz), the signal to noise ratio may be degraded. Degradation of up to 60 dB at a frequency corresponding to the modulation signal may be experienced under extreme conditions (3 V/m, 90% modulation).

Connecting up

The DL231 I/O unit uses the following leads and connectors:

Primary Analogue Inputs:

Mic/Line Inputs - Balanced XLR connectors - 10K load

Primary Analogue Outputs:

Main Outputs - Balanced XLR connectors - 50R Source

AES50 Connections:

Neutrik EtherCON with status indication

Ethernet Control Connection:

Neutrik EtherCON with status indication

Diagnostics Connection:

9 W Female 'D' type connector

Power Connections:

IEC mains inlet – 100-240 V AC~50-60 Hz

For further information about the connectors used in conjunction with the DL231 I/O unit, see Section 5. Connectors.

3. Front Panel

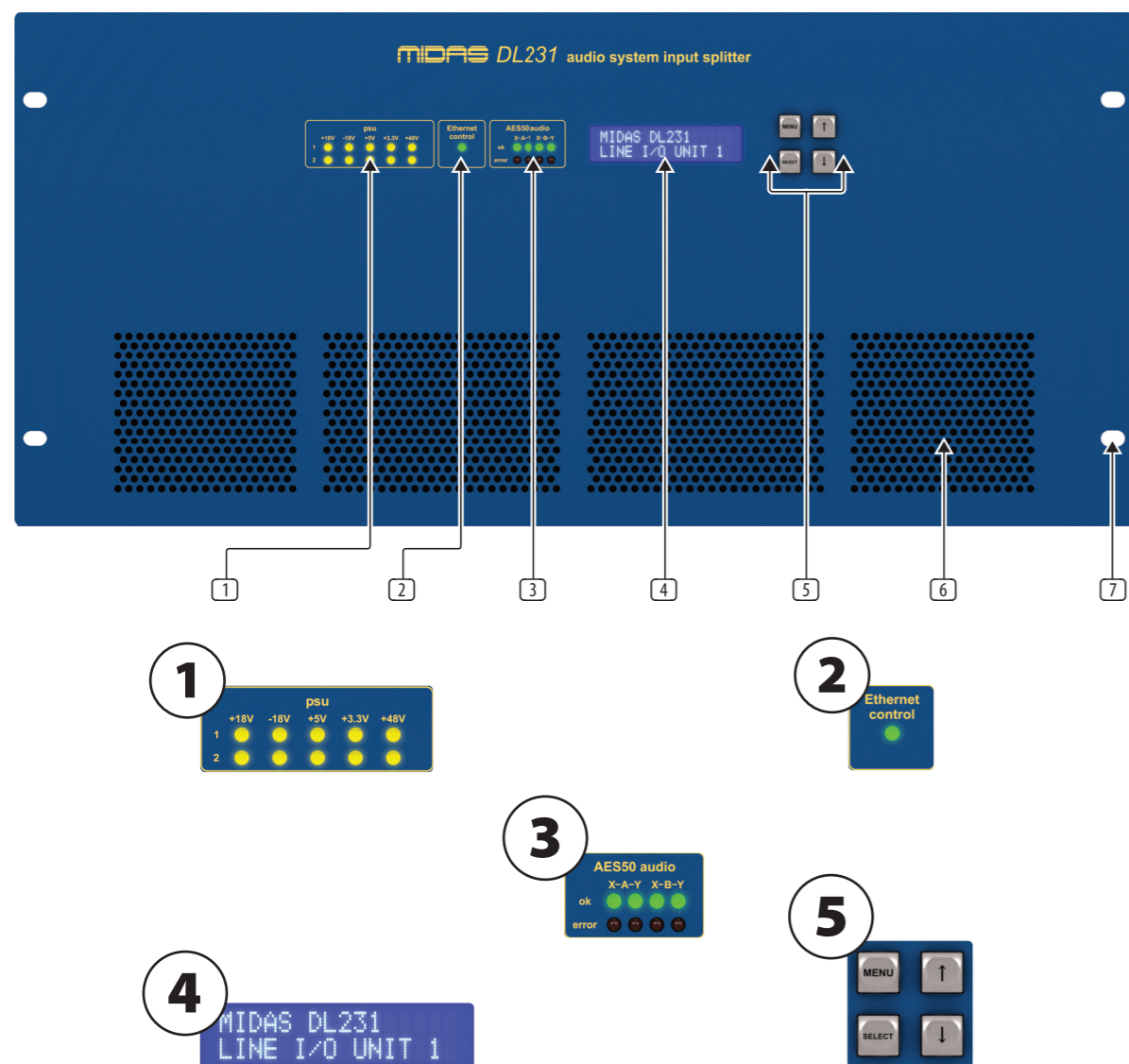

- 1 The **psu** panel monitors the two voltage supplies. There are five yellow LEDs per voltage supply, and each LED represents a voltage rail. An LED will illuminate when its respective voltage rail is active.
- 2 The **Ethernet control** panel has a single green LED, which has three states of illumination: flashing = active; on = connected; and off = not connected.
- 3 The **AES50 audio** panel shows the health status of the communications of the AES50 connections. If the green **ok** LED is illuminated, communication is good. However, if the red **error** LED is illuminated, there is a problem on that connection.

- 4 **LCD Display** - 2 x 16 character blue backlit liquid crystal display.
- 5 **Configuration Control** - 'Menu', 'Select', 'Up' and 'Down' buttons for configuring menu items.
- 6 There are four air intakes for fan cooling. **Do not obstruct.**
- 7 There are four cut-outs for rack mounting fixings.

4. Rear Panel

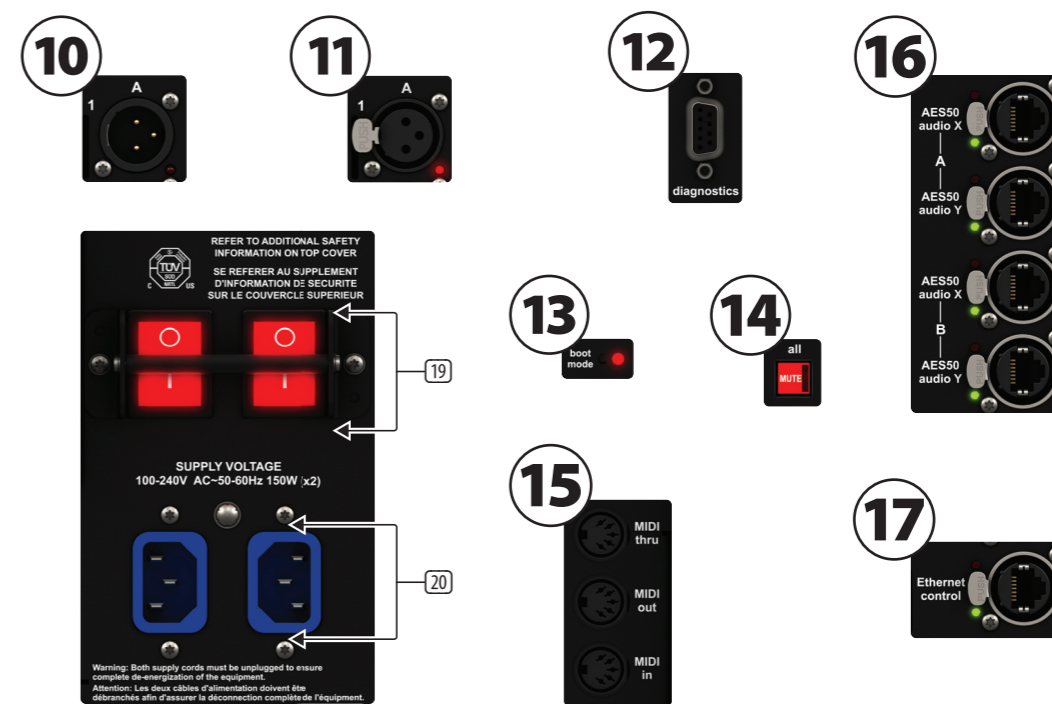
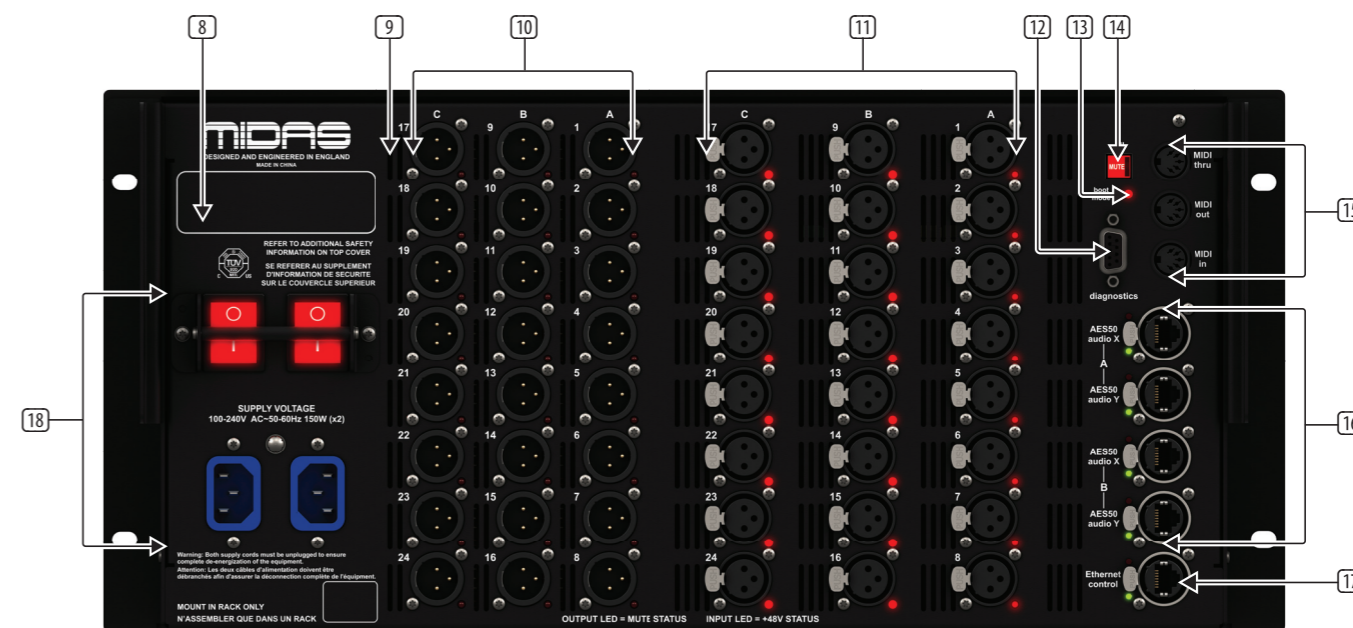

- 8 Unit serial number label.
- 9 Ventilation grills, which provide an air outtake for fan cooling of the inside of the unit.
- 10 Male XLR chassis connectors, which provide outputs for line equipment. Each socket has a red LED that illuminates when mute is on for that output.
- 11 Female XLR chassis connectors, which provide inputs for mic/line equipment. Each socket has a red LED that illuminates when +48 V phantom power is on for that input.
- 12 The **diagnostics** connector is a 9-way D-type connector for connecting a laptop/PC by service personnel for diagnostics purposes. **This is not an operator function and is only to be used by service personnel.**
- 13 The **boot mode** switch selects between normal operation and a service personnel-only configuration boot mode. It has an adjacent red LED, which illuminates to show when the unit is in service only configuration mode.
- 14 The **MUTE** button mutes all the outputs simultaneously when held down for longer than one second. It has an integral LED that illuminates when mute is active.
- 15 There are three MIDI (musical instrument digital interface) sockets — **MIDI in**, **MIDI out** and **MIDI thru** — for connection of a MIDI device, such as a synthesiser. The **MIDI in** socket receives MIDI data, and the **MIDI thru** socket gives out the same MIDI data that is received by the **MIDI in** socket. The **MIDI out** socket gives out MIDI data generated by the attached MIDAS Digital Console.

16 Four **AES50 audio** EtherCON sockets provide connection to the console and pass audio and control data in both directions. Each socket has a pair of red and green LEDs, which indicate the following:

- Green pulsating and red extinguished = valid audio and valid control data; active link.
- Green constantly illuminated and red extinguished = valid audio and valid control data; standby link.
- Green extinguished and red illuminated = no audio; link has failed.

17 The **Ethernet control** EtherCON socket on the rear panel allows Ethernet control via Cat 5e cable up to 100 m long. This socket has a green LED that indicates the following:

- Green LED solid = connected but not active
- Green LED flashing = active
- Green LED extinguished = fault or no connection

Mains power



Each mains inlet should be sourced from its own separate wall-mounted mains outlet socket. Otherwise, both mains sources must be suitably distributed so as to meet local safety regulations.

The mains is supplied to the DL231 via dual redundant mains inlets.

- 18 Dual redundant power supplies.
- 19 Mains on/off isolator switch.
- 20 Mains IEC socket.

5. Connectors

To ensure the correct and reliable operation of the equipment, only high quality balanced, screened, twisted pair audio cable should be used. XLR connector shells should be of metal construction so that they provide a screen when connected to the console/snake and, where appropriate, they should have Pin 1 connected to the cable screen.

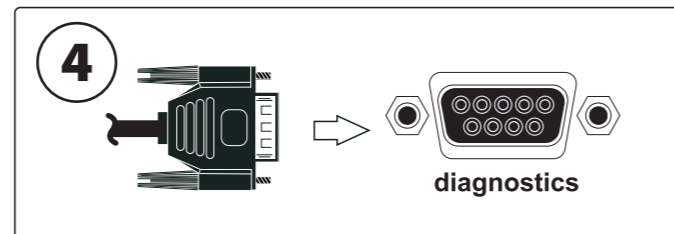
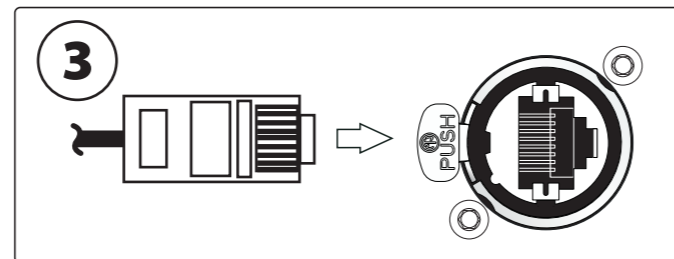
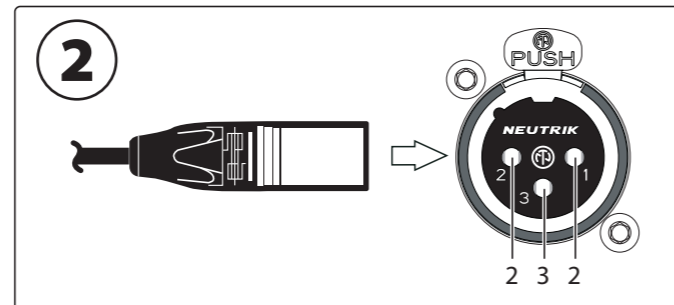
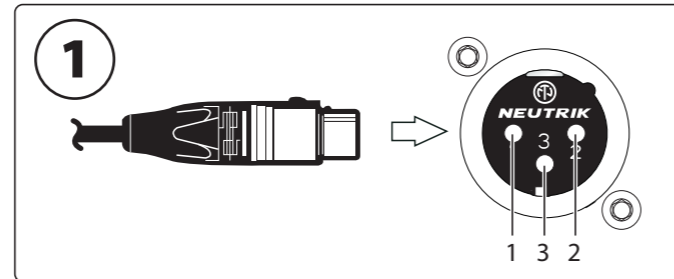

- 1 **Line output audio connector.** Female XLR plug and male XLR chassis connector with the following pinouts: 1 = ground; 2 = hot; and 3 = cold.
- 2 **Mic/line input audio connector.** Male XLR plug and female XLR chassis connector with the following pinouts: 1 = ground; 2 = hot; and 3 = cold.
- 3 **Ethernet socket.** RJ45 plug and EtherCON socket.
- 4 **Diagnostics.** 9-way, D-type plug and socket.

6. Operation

Programming Mode

This chapter describes the programming mode of the DL231 I/O Unit.

Menu navigation

The four programming buttons in the control panel have the following functions.

Navigation buttons	Usage
	Moves up or down a menu level, or exits programming mode, depending on the current menu level.
	Selects the current option.
	Scrolls through the current level of menus/options.
	Scrolls through the current level of menus/options in the opposite direction to the up arrow button.

The menu flowcharts on pages 17 through 21 give an overview of all the menus and their options, and shows you how to navigate your way around them. In the diagram the menus are shown on the left, and each subsequent lower level is to the right.

To enter/exit programming mode

To enter programming mode, press the **MENU** button and hold down for approximately two seconds; the default display will change to the top-level "Select Menu:" display (see "Menus" on this page).

To exit programming mode from any menu display screen, press **MENU** repeatedly until you reach the default screen. The unit will exit programming mode automatically after about 20 seconds of inactivity if none of the programming buttons are pressed within that time.

To select a menu

In programming mode, scroll to the menu you want by using the up/down arrow buttons, then press **SELECT**.

Menus

The eight menus in programming mode are as follows:

1. **MicSplit ID** – for setting up the unit's network ID (see "MicSplit ID Menu" below).
2. **AES50 Sync** – for selecting the method for synchronizing the AES50 (see "AES50 Sync Menu" below).
3. **Output Source** – for setting up the output signal routing from the unit's analogue or AES50 digital inputs.
4. **48 V Control** – for controlling the source of 48 V phantom power.
5. **Sample Rate** – allows you to set the unit's sample rate (48k or 96k sample rates).
6. **AES50 Status** – lets you view/clear the AES50 values.
7. **S/W Version** – for viewing the unit's software version number.
8. **Reset All** – lets you reset all settings to default.

In programming mode the four programming buttons in the control panel are used to navigate and select options from a number of menus, which let you set up the unit and view information.

Menu Flowchart

Menu 1: MicSplit ID

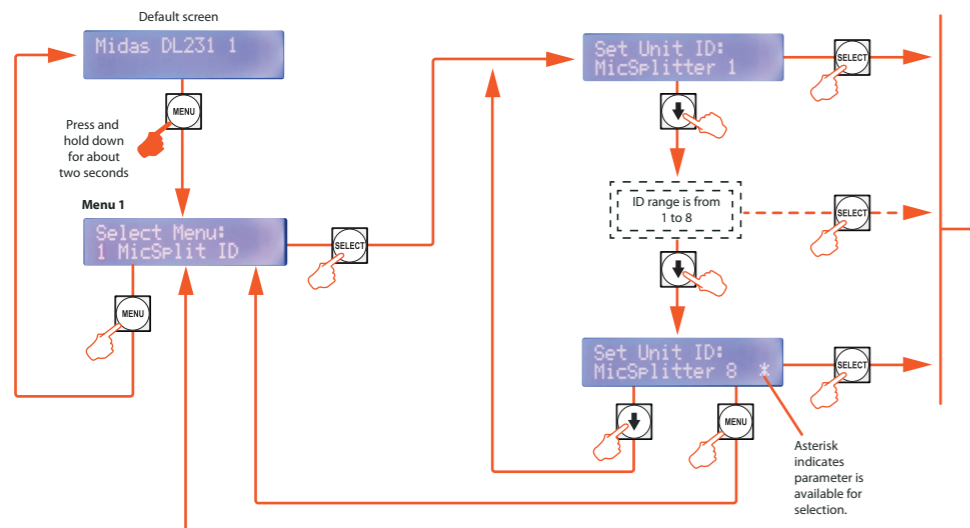

Menu 2: AES50 Sync

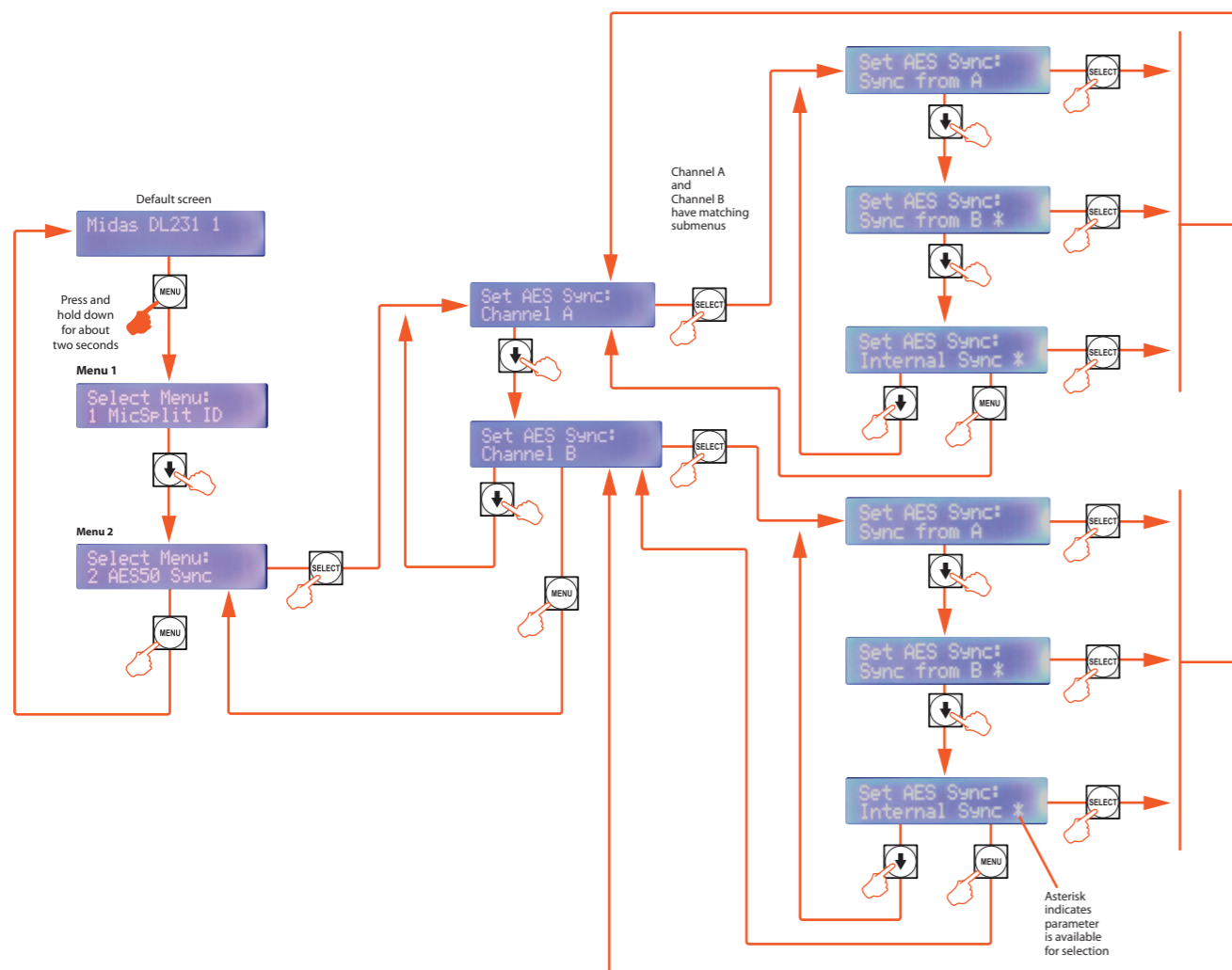

Menu 3: Output Source

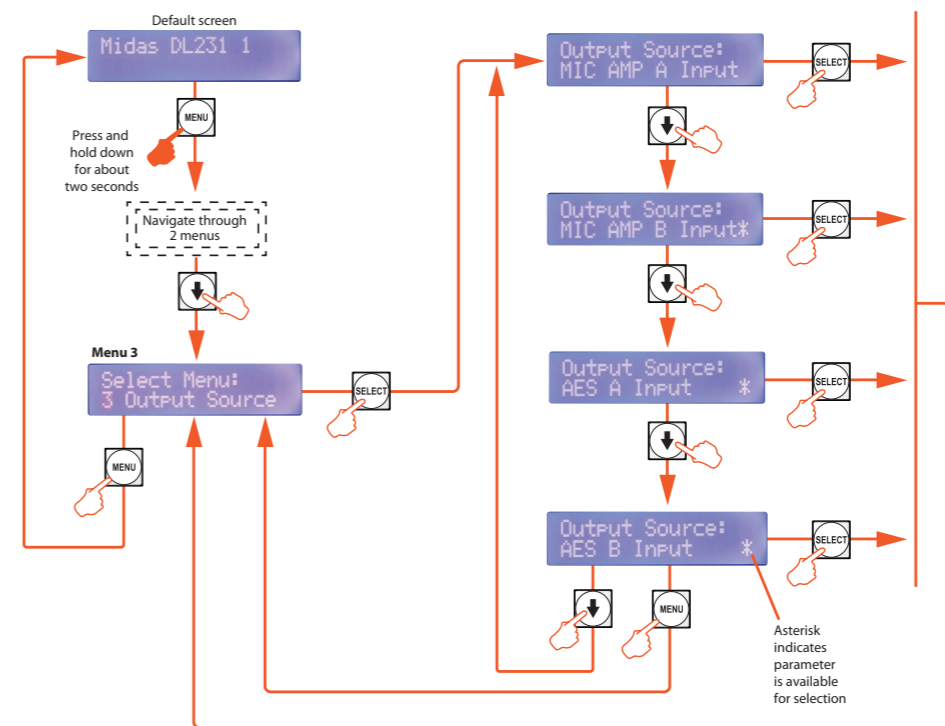

Menu 4: 48 V Control

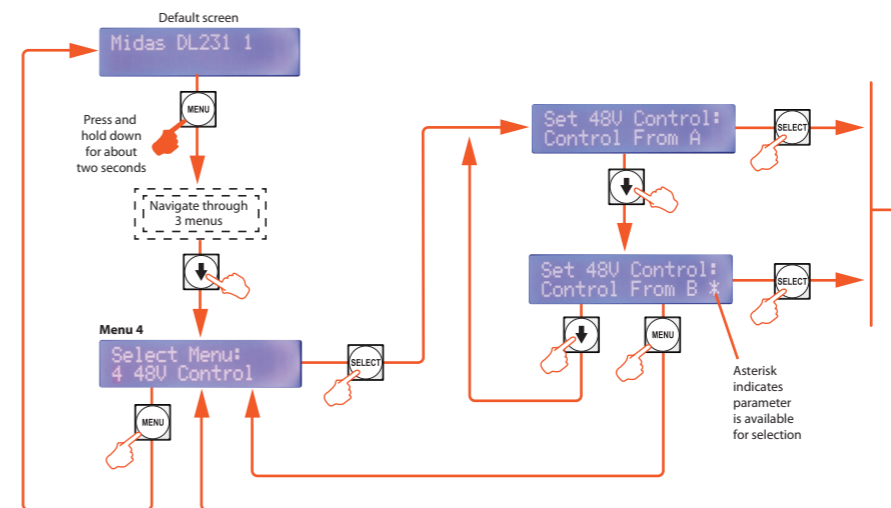

7. Technical Specifications

This section contains the technical specifications for the DL231 I/O unit.

Due to our policy of continual improvement, MIDAS reserves the right to alter the function or specification at any time without notice.

General Statistics

XLR Connections	
DL231	
1 x 5U rack I/O box houses:	24 x (XLR) mic/line inputs (48 mic/line amps) 24 x (XLR) line outputs
Resilience	
Dual redundant network cables and dual redundant PSUs	

General Specifications

Sampling frequency	48 kHz/96 kHz
Dynamic range @ 1 kHz	22 Hz to 22 kHz (at unity gain): > 107 dB
Maximum gain	45 dB
Crosstalk @ 1 kHz	-90 dB physically adjacent input channels
Crosstalk @ 10k HZ	-90 dB physically adjacent input channels
Dimensions	5U x 410 mm deep
Net weight	15 kg
Shipping weight	18 kg
Power requirements	100 V to 240 V AC \pm 10%, 50 to 60 Hz
Power consumption	<150 W
Operating temperature range	+5° C to +40° C
Storage temperature range	-20° C to +60° C

Audio Performance Specifications

Frequency response				
Input	Output	Gain	20 Hz	20 kHz
DL231 I/O Box	DL231 I/O Box	0 dB	+0 dB to -1 dB	+0 dB to -1 dB
DL231 I/O Box	DL231 I/O Box	45 dB	+0 dB to -1 dB	+0 dB to -1 dB
Gain error at 1 kHz				
Input	Output	Gain	Max.	Min.
DL231 I/O Box	DL231 I/O Box	0 dB	+1 dB	-1 dB
DL231 I/O Box	DL231 I/O Box	45 dB	+1 dB	-1 dB
Input CMRR Typical				
Input	Output	Gain	100 Hz	1 kHz
DL231 I/O Box	DL231 I/O Box	0 dB	70 dB	70 dB
DL231 I/O Box	DL231 I/O Box	45 dB	90 dB	90 dB
Distortion at 0 dBu				
Input	Output	Gain	1 kHz	10 kHz
DL231 I/O Box	DL231 I/O Box	0 dB	0.01%	0.01%
DL231 I/O Box	DL231 I/O Box	45 dB	0.03%	0.03%
Distortion at +20 dBu				
Input	Output	Gain	1 kHz	10 kHz
DL231 I/O Box	DL231 I/O Box	0 dB	0.01%	0.01%
DL231 I/O Box	DL231 I/O Box	45 dB	0.03%	0.03%

Signal path noise 22 Hz to 22 kHz unweighted (inputs 150 Ω terminated)

Input	Output	Gain	Output noise	EIN
DL231 I/O Box	DL231 I/O Box	0 dB	-86 dBu	-86 dBu
DL231 I/O Box	DL231 I/O Box	45 dB	-81 dBu	-126 dBu

Dynamic range 22 Hz to 22 kHz unweighted

Input	Output	Gain	Maximum level	Dynamic range
DL231 I/O Box	DL231 I/O Box	0 dB	+21 dBu	107 dB
DL231 I/O Box	DL231 I/O Box	45 dB	+21 dBu	102 dB

System Inputs and Outputs

I/O Box inputs	
Connector	3-pin XLR balanced
A/D converter	24-bit, 96 kHz and 128 times oversampling
I/O Box outputs	
Connector	3-pin XLR balanced
D/A converter	24-bit, 96 kHz and 128 times oversampling
MIDI	
MIDI connector	In, out and through on 5-pin DIN (for use with MIDAS consoles only)
48 kHz I/O digital system inputs and outputs	
System connector A (X)	1 x AES50 (24 channels of bi-directional digital audio) on EtherCON XLR
Redundant connector A (Y)	1 x AES50 (24 channels of bi-directional digital audio) on EtherCON XLR providing redundant backup
System connector B (X)	1 x AES50 (24 channels of bi-directional digital audio) on EtherCON XLR
Redundant connector B (Y)	1 x AES50 (24 channels of bi-directional digital audio) on EtherCON XLR providing redundant backup
96 kHz I/O digital system inputs and outputs	
System connector A (X)	1 x AES50 (24 channels of bi-directional digital audio) on EtherCON XLR
Redundant connector A (Y)	1 x AES50 (24 channels of bi-directional digital audio) on EtherCON XLR providing redundant backup
System connector B (X)	1 x AES50 (24 channels of bi-directional digital audio) on EtherCON XLR
Redundant connector B (Y)	1 x AES50 (24 channels of bi-directional digital audio) on EtherCON XLR providing redundant backup

Input and Output Characteristics

Analogue input characteristics

Input	Load Z	Gain	Max. level	Connector
DL231 I/O Box	10 k Ω	-2.5 dB to +45 dB	+24 dBu	XLR

Analogue output characteristics

Output	Source Z	Gain	Max. level	Connector
DL231 I/O Box	50 Ω	0 dB	+21 dBu	XLR

48 kHz digital I/O characteristics

Type	AES50
Channels	24
Data length	24-bit
I/O	Bi-directional
Description notes	Conforms to AES50-2011
Connector	EtherCON XLR

96 kHz digital I/O characteristics

Type	AES50
Channels	24
Data length	24-bit
I/O	Bi-directional
Description notes	Conforms to AES50-2011
Connector	EtherCON XLR

Other important information

EN Important information

1. Register online. Please register your new MUSIC Group equipment right after you purchase it by visiting midasconsoles.com. Registering your purchase using our simple online form helps us to process your repair claims more quickly and efficiently. Also, read the terms and conditions of our warranty, if applicable.

2. Malfunction. Should your MUSIC Group Authorised Reseller not be located in your vicinity, you may contact the MUSIC Group Authorised Fulfiller for your country listed under "Support" at midasconsoles.com. Should your country not be listed, please check if your problem can be dealt with by our "Online Support" which may also be found under "Support" at midasconsoles.com. Alternatively, please submit an online warranty claim at midasconsoles.com BEFORE returning the product.

3. Power Connections. Before plugging the unit into a power socket, please make sure you are using the correct mains voltage for your particular model. Faulty fuses must be replaced with fuses of the same type and rating without exception.

FR Informations importantes

1. Enregistrez-vous en ligne. Prenez le temps d'enregistrer votre produit MUSIC Group aussi vite que possible sur le site Internet midasconsoles.com. Le fait d'enregistrer le produit en ligne nous permet de gérer les réparations plus rapidement et plus efficacement. Prenez également le temps de lire les termes et conditions de notre garantie.

2. Dysfonctionnement. Si vous n'avez pas de revendeur MUSIC Group près de chez vous, contactez le distributeur MUSIC Group de votre pays : consultez la liste des distributeurs de votre pays dans la page "Support" de notre site Internet midasconsoles.com. Si votre pays n'est pas dans la liste, essayez de résoudre votre problème avec notre "aide en ligne" que vous trouverez également dans la section "Support" du site midasconsoles.com. Vous pouvez également nous faire parvenir directement votre demande de réparation sous garantie par Internet sur le site midasconsoles.com AVANT de nous renvoyer le produit.

3. Raccordement au secteur. Avant de relier cet équipement au secteur, assurez-vous que la tension secteur de votre région soit compatible avec l'appareil. Veillez à remplacer les fusibles uniquement par des modèles exactement de même taille et de même valeur électrique — sans aucune exception.

PT Outras Informações Importantes

1. Registre-se online. Por favor, registre seu novo equipamento MUSIC Group logo após a compra visitando o site midasconsoles.com. Registrar sua compra usando nosso simples formulário online nos ajuda a processar seus pedidos de reparos com maior rapidez e eficiência. Além disso, leia nossos termos e condições de garantia, caso seja necessário.

2. Funcionamento Defeituoso. Caso seu fornecedor MUSIC Group não esteja localizado nas proximidades, você pode contatar um distribuidor MUSIC Group para o seu país listado abaixo de "Suporte" em midasconsoles.com. Se seu país não estiver na lista, favor checar se seu problema pode ser resolvido com o nosso "Suporte Online" que também pode ser achado abaixo de "Suporte" em midasconsoles.com. Alternativamente, favor enviar uma solicitação de garantia online em midasconsoles.com ANTES da devolução do produto.

3. Ligações. Antes de ligar a unidade à tomada, assegure-se de que está a utilizar a voltagem correcta para o modelo em questão. Os fusíveis com defeito terão de ser substituídos, sem qualquer excepção, por fusíveis do mesmo tipo e corrente nominal.

CN 其他的重要信息

1. 在线注册。请购买 MUSIC Group 产品后立即在 midasconsoles.com 网站注册。网页上有简单的在线注册表格。这有助于我们更快更有效率地处理您维修等事宜。请阅读保修的相关条款及条件。

2. 无法正常工作。若您的 MUSIC Group 产品无法正常工作,我们会为您尽快修复。请联系您购买产品的销售商。若你所在地区没有 MUSIC Group 销售商,请联系 midasconsoles.com 网站的 "WHERE TO BUY" 一栏下的所列出的子公司或经销商。

3. 电源连接。将本设备连接电源前,请确保使用的电压正确。保险丝需要更换时,必须使用相同型号及定额的保险丝。

ES Aspectos importantes

1. Registro online. Le recomendamos que registre su nuevo aparato MUSIC Group justo después de su compra accediendo a la página web midasconsoles.com. El registro de su compra a través de nuestro sencillo sistema online nos ayudará a resolver cualquier incidencia que se presente a la mayor brevedad posible. Además, aproveche para leer los términos y condiciones de nuestra garantía, si es aplicable en su caso.

2. Averías. En el caso de que no exista un distribuidor MUSIC Group en las inmediaciones, puede ponerse en contacto con el distribuidor MUSIC Group de su país, que encontrará dentro del apartado "Support" de nuestra página web midasconsoles.com. En caso de que su país no aparezca en ese listado, acceda a la sección "Online Support" (que también encontrará dentro del apartado "Support" de nuestra página web) y compruebe si su problema aparece descrito y solucionado allí. De forma alternativa, envíenos a través de la página web una solicitud online de soporte en periodo de garantía ANTES de devolvernos el aparato.

3. Conexiones de corriente. Antes de enchufar este aparato a una salida de corriente, asegúrese de que dicha salida sea del voltaje adecuado para su modelo concreto. En caso de que deba sustituir un fusible quemado, deberá hacerlo por otro de idénticas especificaciones, sin excepción.

DE Weitere wichtige Informationen

1. Online registrieren. Bitte registrieren Sie Ihr neues MUSIC Group-Gerät direkt nach dem Kauf auf der Website midasconsoles.com. Wenn Sie Ihren Kauf mit unserem einfachen online Formular registrieren, können wir Ihre Reparaturanträge schneller und effizienter bearbeiten. Lesen Sie bitte auch unsere Garantiebedingungen, falls zutreffend.

2. Funktionsfehler. Sollte sich kein MUSIC Group Händler in Ihrer Nähe befinden, können Sie den MUSIC Group Vertrieb Ihres Landes kontaktieren, der auf midasconsoles.com unter „Support“ aufgeführt ist. Sollte Ihr Land nicht aufgelistet sein, prüfen Sie bitte, ob Ihr Problem von unserem „Online Support“ gelöst werden kann, den Sie ebenfalls auf midasconsoles.com unter „Support“ finden. Alternativ reichen Sie bitte Ihren Garantieanspruch online auf midasconsoles.com ein, BEVOR Sie das Produkt zurücksenden.

3. Stromanschluss. Bevor Sie das Gerät an eine Netzsteckdose anschließen, prüfen Sie bitte, ob Sie die korrekte Netzspannung für Ihr spezielles Modell verwenden. Fehlerhafte Sicherungen müssen ausnahmslos durch Sicherungen des gleichen Typs und Nennwerts ersetzt werden.

JP その他の重要な情報

1. ヒューズの格納部 / 電圧の選択: ユニットをパワーソケットに接続する前に、各モデルに対応した正しい主電源を使用していることを確認してください。ユニットによっては、230V と 120V の 2 つの違うポジションを切り替えて使う、ヒューズの格納部を備えているものがあります。正しくない値のヒューズは、絶対に適切な値のヒューズに交換されている必要があります。

2. 故障: MUSIC Group デイラーがお客様のお近くにならないときは、midasconsoles.com の "Support" 内に列記されている、お客様の国の MUSIC Group ディストリビューターにコンタクトすることができます。お客様の国がリストにない場合は、同じ midasconsoles.com の "Support" 内にある "Online Support" でお客様の問題が処理できないか、チェックしてみてください。あるいは、商品を返送する前に、midasconsoles.com で、オンラインの保証請求を要請してください。

3. 電源接続: 電源ソケットに電源コードを接続する前に、本製品に適切な電圧を使用していることをご確認ください。不具合が発生したヒューズは必ず電圧および電流、種類が同じヒューズに交換する必要があります。

FEDERAL COMMUNICATIONS COMMISSION COMPLIANCE INFORMATION



Responsible Party Name: **MUSIC Group Research
UK Limited**

Address: **Klark Industrial Park,
Walter Nash Road,
Kidderminster. Worcestershire.
DY11 7HJ. England.**

Phone Number: **+44 1562 741515**

DL231

complies with the FCC rules as mentioned in the following paragraph:

This equipment has been tested and found to comply with the limits for a Class A digital device, pursuant to Part 15 of the FCC Rules. These limits are designed to provide reasonable protection against harmful interference when the equipment is operated in a commercial environment. This equipment generates, uses, and can radiate radio frequency energy and, if not installed and used in accordance with the instruction manual, may cause harmful interference to radio communications. Operation of this equipment in a residential area is likely to cause harmful interference in which case the user will be required to correct the interference at his own expense.

Important information:

Changes or modifications to the equipment not expressly approved by MUSIC Group can void the user's authority to use the equipment.

EN

ES

FR

DE

PT

JP

CN

